

MeasurLink ENABLED
Data Management Software by Mitutoyo



SPRING PROMO 2024

PRECISION TOOLS & INSTRUMENTS

Effective March 15, 2024 through June 28, 2024

SPRING PROMO 2024

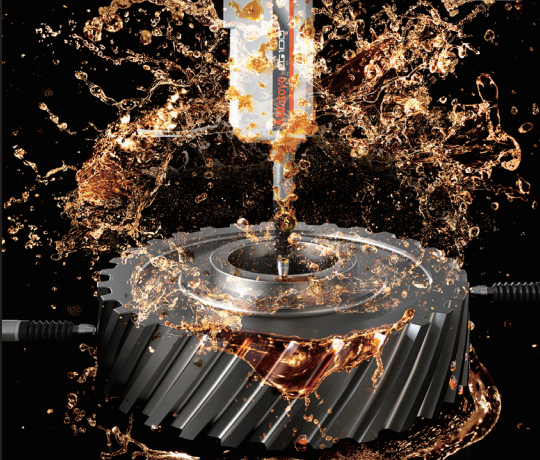

NEW Products **NEW FEATURED PRODUCTS**

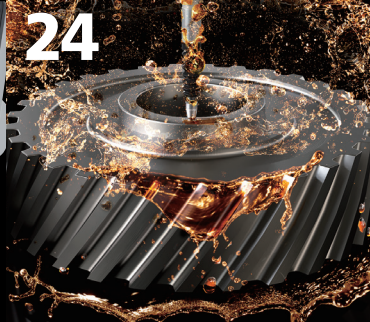

Dear Valued Customers,
 I want to take a moment to express my sincere appreciation for your continued support and commitment to Mitutoyo products and services. The 2024 spring promotion features many great Mitutoyo precision measurement instruments such as the very popular, redesigned LH600F/FG Linear Height Gage, new IDC/IDF indicators, the SJ-210 surface roughness testers, profile projectors and several different types of linear gages. The promotion also features many other trusted Mitutoyo tools and instruments including data management solutions, calipers, micrometers, linear encoders, test indicators, height gages, microscopes, hardness testers, and contact sensors such as linear gages and the motorized Litematic contact gage. Prices are effective March 15, 2024 through June 28, 2024.

You can find all of the latest promotions, products and events on our website, www.mitutoyo.com, as well as on my.mitutoyo.com. Thank you for trusting Mitutoyo with your metrology needs.

Sincerely,
Matt Dye
 President, Mitutoyo America Corporation

Matthew B. Dye

TABLE OF CONTENTS

NEW Surftest 3	Surftest SJ-210 Packages 3
Highly versatile surface roughness instruments available in portable, manual and CNC models full of features and capabilities. Mitutoyo surface roughness testers deliver precise and accurate measurements.	Indicators 4
NEW IDC/IDF Digimatic Indicators 4	Dial Test Indicators 5
These new Digimatic Indicators have higher resolutions down to 20µin/0.5 µm, a built-in calibration date warning and analog bar on the larger LCD display, and new S1 Digimatic output capabilities.	Bore Gages 8
NEW Test Indicators 5	Holtest 9
Mitutoyo digital and dial indicators deliver excellent readability even in adverse environments. Our indicators are ideal for use in peak value and bore gage applications, performing calculations, and detecting minute changes in displacement.	Borematic 11
NEW Profile Projectors 12	Profile Projectors 12
Mitutoyo profile projectors provide some of the most accurate and clear images in the market. Easily capture accurate measurements without blurring, distortion or complex calculations with their day-bright surface illuminations.	Linear Height Gages 14
NEW LH-600F/FG Linear Height Gages 14	Calipers/Caliper Checker 18
The Mitutoyo LH-600F/FG Linear Height Measurement System is the latest model in the Mitutoyo Linear Height Gage line with several new features like an adjustable, rotatable display, intuitive touchscreen interface, and added output options for even easier, highly accurate 2D dimensional measurements.	Micrometers 20
NEW Contact Sensors 24	U-WAVE Bluetooth Wireless Data Transmitters 22
Mitutoyo linear gages deliver durable, reliable measurements for countless applications. The Litematic offers ultra-high precision measurement with extra-low measuring force to measure easily deformed workpieces.	U-WAVE Wireless Data Transmitters 23
	Litematic Units 24
	Linear Gages/EJ Counters 25
	Digimatic Scales 26
	Linear Encoders 27
	Hardness Testers 28
	Laser Scan Micrometers 31
	Microscopes 32
	Digital Microscopes 34
	Digital Profile Projectors 35

Surftest SJ-210 Packages



- > 2.4-inch color LCD display with backlighting is switchable to vertical or horizontal left / right-hand views
- > The built-in battery allows approximately 1,000 measurements on a full charge (4 hours charging time)
- > Performs roughness analysis conforming to international standards JIS '82 / JIS '94 / JIS '01 / ISO '97 / ANSI/VDI
- > Optional MicroSD card can store up to 500 measurement conditions, 10000 measurement results and 500 image data
- > Function restriction feature locks conditions to prevent erroneous measurements if settings are accidentally changed.



UP TO 25% OFF

178-561-12A

Order No.	Spring Promo Price	List	Promo
178-561-12A-SPP	SJ-210 4MN (STANDARD DRIVE UNIT) INCH/MM	\$2,820.00	\$2,232.00
STF-210	eLearning Course	\$30.00	Included

Order No	Calibration Package	List	Promo
178-561-12A-CP	SJ-210 4MN (STANDARD DRIVE UNIT) INCH/MM	\$3,409.00	\$2,650.00
178-390	FREE EXTRA DETECTOR	\$522.00	Included
C178-602	Calibration Specimen fee	\$67.15	Included
STF-210	eLearning Course	\$30.00	Included



178-390

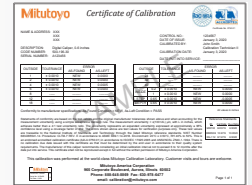

Calibration Certificate

Order No	Data Collection Package	List	Promo
178-561-12A-DC	SJ-210 4MN (STANDARD DRIVE UNIT) INCH/MM	\$3,770.00	\$2,900.00
02AZD730G	U-WAVE TRANSMITTER	\$253.00	Included
02AZD790D	U-WAVE connecting cable D	\$126.00	Included
02AZD810D	U-WAVE RECEIVER	\$571.00	Included
STF-210	eLearning Course	\$30.00	Included



Wireless Communication System

Order No	Height Gage Package	List	Promo
178-561-12A-HG	SJ-210 4MN (STANDARD DRIVE UNIT) INCH/MM	\$4,088.00	\$3,500.00
570-413	Digimatic Height Gage (HDSH18" CX)	\$1,150.00	Included
12AAA233	Height Gage Adapter (INCH)	\$118.00	Included
STF-210	eLearning Course	\$30.00	Included



12AAA233

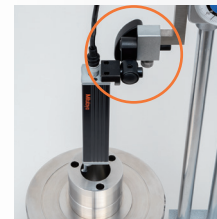

12AAA233



570-413

Order No	Manual Column Stand Package	List	Promo
178-561-12A-MCS	SJ-210 4MN (STANDARD DRIVE UNIT) INCH/MM	\$3,834.00	\$3,450.00
178-069	Column Stand for SJ-210/310/410	\$962.00	Included
12AAA220	Magnetic Stand Adaptor (3/8" DIA)	\$51.85	Included
STF-210	eLearning Course	\$30.00	Included



178-069



12AAA220

IDC/IDF Digimatic Indicators

High-performance ABS Digimatic Indicators

- > **20 pinch/0.5 μm resolution.** The ID-C and ID-F ranges now include models with 0.0005 mm resolution. The units are also capable of resolution switching. *Except for the ID-C 0.01 mm resolution model.
- > **Large screen and analog bar.** The units have large screens that can display various information in an easy-to-read manner. They also have an analog bar, convenient for observing subtle movements such as the approach to tolerance.
- > **New Digimatic S1 Output.** S1 is Mitutoyo's new, bidirectional output format that enables writing information to the gages such as calibration date warnings, operator info, and the ability to poll the serial number (wired or wirelessly) for easier gage management.
- > **Calibration period notification function.** The LCD displays an icon to notify the user when the set calibration time approaches. This facilitates the proper precision management of ID-C/ID-F.

Calibration period notification function

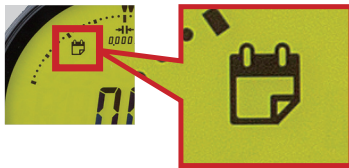

- > **Simple Calculation Function.** The result of the spindle movement value multiplied by the calculation coefficient can be displayed in real time. This reduces the work of measuring with a jig or similar tool.

$$f(x) = Ax$$

f(x): Displayed value
 x: Spindle movement value
 A: Selected value

10% OFF



ID-C Series



ID-F Series

Improved work efficiency thanks to excellent readability

Large screen and analog bar

The units have large screens that can display various information in an easy-to-read manner. They also have an analog bar, convenient for observing subtle movements such as the approach to tolerance.

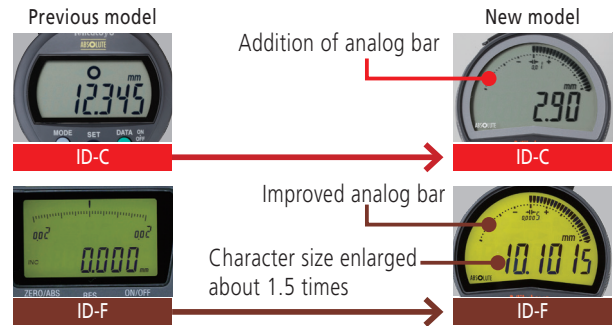

ID-C Series - Battery Operated

Order No.		Range	Resolution	Maximum Permissible Error			Measuring for MPL (N)	Interface	Net mass (g)		List	Promo
With Lug	Flat Back			MPE _E	Hysteresis MPE _H	Repeatability MPE _R			With Lug	Flat Back		
543-702	543-702B	0.5" / 12.7mm	0.00002" / .00005" / 0.0001" / 0.0005" / 0.0005mm / 0.001mm / 0.01mm	± 0.00012" / 0.002mm	0.00008" / 0.002mm	0.00008" / 0.002mm	1.5 or less	d1/d2/S1	195	165	\$501.00	\$450.90
543-707	543-707B	0.5" / 12.7mm					0.4 to 0.7	d1/d2/S1	190	160	\$783.00	\$704.70
-	543-722B	1" / 25.4mm		1.8 or less			d1/d2/S1	-	195	\$645.00	\$580.50	
-	543-732B	2" / 50.8mm		2.3 or less			d1/d2/S1	-	260	\$840.00	\$756.00	
543-712	543-712B	0.5" / 12.7mm	0.0005" / 0.01mm	± 0.001" / 0.02mm	0.001" / 0.02mm	0.0005" / 0.01mm	0.9 or less	d1/S1	190	160	\$366.00	\$329.40
543-717	543-717B	0.5" / 12.7mm					0.2 to 0.5	d1/S1	185	155	\$587.00	\$528.30
-	543-727B	1" / 25.4mm		1.8 or less			d1/S1	-	190	\$537.00	\$483.30	
-	543-737B	2" / 50.8mm		± 0.0015" / 0.04mm			2.3 or less	d1/S1	-	245	\$704.00	\$633.60

ID-F Series - AC Powered

Order No.	Range	Resolution	Maximum Permissible Error			Measuring for MPL (N)	Interface	Net mass (g)	List	Promo
			MPE _E	Hysteresis MPE _H	Repeatability MPE _R					
543-852A	1" / 25.4mm	0.005mm / 0.001mm / 0.01 mm / 0.00002" / .00005" / 0.0001" / 0.0005"/0.001" (selectable)	± 0.0001" / 0.0025mm	0.00008" / 0.002mm	0.00008" / 0.002mm	1.8 or less	d1/d2/S1	240	\$787.00	\$708.30
543-854A	2" / 50.8mm		± 0.00016" / 0.004mm			2.3 or less	d1/d2/S1	330	\$894.00	\$804.60
543-858A			± 0.00012" / 0.003mm			2.3 or less	d1/d2/S1	330	\$912.00	\$820.80

Prices effective March 15, 2024 through June 28, 2024

Dial Test Indicators



513-404-10E
Standard

.000050" / 50μinch model now available!

- > One-piece movement assembly for improved durability & impact resistance.
- > Contact point length shown on dial face.
- > Certificate of Inspection included.
- > Shows results from both measuring directions.
- > Resilient crystal with high resistance to glare, scratches and impact.

10%
OFF



Contact point length is printed on dial face to avoid accuracy issues

Part #	Range	Graduations	Set Type	Face Color	List	Promo	Remarks
Standard							
513-407-10E	.008"	.00005"	Basic	White	\$220.00	\$198.00	Fine grads
513-407-10T	.008"	.00005"	Full	White	\$258.00	\$232.20	Fine grads
513-401-10E	.14"	0.001mm	Basic	Yellow	\$262.00	\$235.80	
513-402-10E	.03"	.0005"	Basic	White	\$153.00	\$137.70	
513-402-10T	.03"	.0005"	Full	White	\$182.00	\$163.80	
513-403-10E	.008"	.0001"	Basic	White	\$199.00	\$179.10	
513-403-10T	.008"	.0001"	Full	White	\$234.00	\$210.60	
513-404-10E	0.8mm	0.01mm	Basic	Yellow	\$155.00	\$139.50	
513-404-10A	0.8mm	0.01mm	Plus	Yellow	\$171.00	\$153.90	
513-404-10T	0.8mm	0.01mm	Full	Yellow	\$183.00	\$164.70	
513-405-10E	0.2mm	0.002mm	Basic	Yellow	\$173.00	\$155.70	
513-405-10T	0.2mm	0.002mm	Full	Yellow	\$226.00	\$203.40	
513-406-10E	.03"/0.7mm	.0005"/0.01mm	Basic	White/Yellow	\$180.00	\$162.00	Dual dial
513-406-10T	.03"/0.7mm	.0005"/0.01mm	Full	White/Yellow	\$199.00	\$179.10	Dual dial
513-409-10E	0.2mm/.0076"	0.002mm/.0001"	Basic	Yellow/White	\$232.00	\$208.80	Dual dial
513-409-10T	0.2mm/.0076"	0.002mm/.0001"	Full	Yellow/White	\$235.00	\$211.50	Dual dial
513-412-10E	.03"	.0005"	Basic	White	\$220.00	\$198.00	
513-412-10T	.03"	.0005"	Full	White	\$254.00	\$228.60	
513-415-10E	1.0mm	0.01mm	Basic	Yellow	\$165.00	\$148.50	Long stylus
513-415-10H	1.0mm	0.01mm	Basic	Yellow	\$181.00	\$162.90	Long stylus
Ruby Tip							
513-472-10E	.03"	.0005"	Basic	White	\$171.00	\$153.90	
513-479-10E	.03"	.0005"	Basic	White	\$181.00	\$162.90	Long stylus
Standard (20° tilted face)							
513-442-10A	.06"	.0005"	Basic	White	\$208.00	\$187.20	
513-442-10T	.06"	.0005"	Full	White	\$235.00	\$211.50	
513-442-16A	.06"	.0005"	Basic	Black	\$208.00	\$187.20	
513-442-16T	.06"	.0005"	Full	Black	\$235.00	\$211.50	
513-446-16A	.06"	.0005"	Basic	Black	\$278.00	\$250.20	Long stylus
513-446-16T	.06"	.0005"	Full	Black	\$313.00	\$281.70	Long stylus
513-446-10A	.06"	.0005"	Basic	White	\$278.00	\$250.20	Long stylus
513-446-10T	.06"	.0005"	Full	White	\$313.00	\$281.70	Long stylus
513-443-10A	.016"	.0001"	Basic	White	\$262.00	\$235.80	
513-443-10T	.016"	.0001"	Full	White	\$296.00	\$266.40	
Vertical: dial is on the top of the frame							
513-452-10E	.03"	.0005"	Basic	White	\$199.00	\$179.10	
513-452-10T	.03"	.0005"	Full	White	\$220.00	\$198.00	
513-453-10E	.008"	.0001"	Basic	White	\$237.00	\$213.30	
Parallel: dial is on the side of the frame							
513-485-10E	0.2mm	0.002mm	Basic	Yellow	\$254.00	\$228.60	

Set Configuration

Inch

Full set

- Contact point, .039" DIA. carbide
- Contact point, .118" DIA. carbide
- Stem, .157" DIA. (21CAB106)
- Swivel clamp (900322, for .157" DIA., 3/8" DIA., dovetail)
- Inch holding bar (L: 4") (900306)

Basic set

- Contact point, .079" DIA. (Carbide)
- Indicator
- Knurled clamp ring
- Stem, .157" DIA. (21CAB106)
- Stem, 3/8" DIA.

Metric

Full set

- Swivel clamp (900321, for ø4mm, ø8mm, dovetail)
- Metric holding bar (L: 100mm) (900209)

Plus set

- Contact point, ø1mm carbide
- Contact point, ø3mm carbide
- Stem, ø4mm (21CAB106)

Basic set

- Contact point, ø2mm (Carbide)
- Indicator
- Knurled clamp ring
- Stem, ø8mm (Set No. 902804)

Labels:

- T set
- E, A set
- A set
- C set (ø 6 Stem)
- E set
- H set (ø 6 Stem)

Calculation-Type Digimatic Indicator ID-C

- › Calculation-Type Digimatic Indicator features both a key lock and parameter lock.
- › Fast measurement frequency up to 50 per second.
- › An analog bar provides easy-to-read values when scanning for Max, Min and TIR Values.
- › Improved parameter setting software makes it even easier to set all of the available parameters and determine and upload the proper coefficients for calculation. (optional) **21EZA313**
- › The ABSOLUTE Digimatic indicator performs internal calculations using the formula $Ax+B+Cx-1$ (assuming spindle displacement as x), while the specified

coefficients A, B and C can be set with respect to the purpose of measurement or dimensions of the fixtures. This unique feature allows for reading measurements directly, without searching for conversions.



SPC ABSOLUTE

MeasurLink ENABLED
Data Management Software by Mitutoyo

10% OFF



Order No.	Resolution	Range	Accuracy	Measuring Force	List	Promo
543-342B-10	.00005/.0001/.0005" (0.001/0.01mm) Selectable	.5"/12.7mm	±.00010"/0.003mm	1.5N or less	\$524.00	\$471.60

Stem dia. 3/8" #4-48 UNF Thread

SPC cable – 1m: **905338** 2m: **905409**

Bore Gage ABSOLUTE Digimatic Indicator ID-C



Installed on optional bore gage probe (page 9)

- › Hold automatically picks up hole diameter after a sweep.
- › Bore Gage Digimatic Indicator features both a key lock and parameter lock.
- › Fast measurement frequency up to 50 per second.
- › An analog bar indicator is integrated to enhance the intuition in reading.
- › Up to three sets of master values and upper/lower tolerance values can be memorized.

- › GO/NO-GO judgment
- › Employing the ABSOLUTE linear encoder, the ID-C always displays the spindle Absolute Position from the origin at power-on.
- › Improved parameter setting software makes it even easier to set all of the available parameters and determine and upload the proper coefficients for calculation. (optional) **21EZA313**

MeasurLink ENABLED
Data Management Software by Mitutoyo

10% OFF



Order No.	Resolution	Range	Accuracy	Measuring Force	List	Promo
543-312B-10	.00005/.0001/.0005" (0.001/0.01mm) Selectable	.5"/12.7mm	±.00010"/0.003mm	1.5N or less	\$524.00	\$471.60

SPC cable – 1m: **905338** 2m: **905409**

SPC ABSOLUTE

Peak Hold ABSOLUTE Digimatic Indicator ID-C

With Max./Min. Value Holding Function

- › Peak Hold Digimatic Indicator features both a Key Lock and Parameter Lock.
- › An analog bar provides easy-to-read values when scanning for Max, Min and TIR Values.
- › GO/NO-GO judgment
- › The maximum, minimum or runout value can be displayed during measurement.

- › Fast measurement frequency up to 50 per second.
- › Employing the ABSOLUTE linear encoder, the Signal ID-C always displays the spindle Absolute Position from the origin at power-on.
- › Improved parameter setting software makes it even easier to set all of the available parameters and then determine and upload the proper coefficients for calculation. (optional) **21EZA313**

15% OFF



Order No.	Resolution	Range	Accuracy	Remarks	List	Promo
Stem dia. 3/8", #4-48 UNF Thread						
543-302-10	.00005/.0001/.0005" 0.001/0.01mm Selectable	.5"/12.7mm	±.00010"/0.003mm	w/lug	\$524.00	\$445.40
543-302B-10		.5"/12.7mm	±.00010"/0.003mm	Flat-back	\$524.00	\$445.40

SPC ABSOLUTE

MeasurLink ENABLED
Data Management Software by Mitutoyo

SPC cable – 1m: **905338** 2m: **905409**

Prices effective March 15, 2024 through June 28, 2024

Digimatic Indicator ID-H

Remote Programming Capable

> This digital indicator offers the excellent accuracy and functionality expected from this class of indicator. Take advantage of its high accuracy backed up by 0.5µm / .00002" resolution, remote control functionality via a handheld controller (or an RS-232C interface) and easy runout measurements with the well-established analog bar display.

> The maximum, minimum or runout value can be displayed during measurement.
 > GO/NO-GO judgment is performed by setting the upper and lower tolerances. If a judgment result is out of tolerance, the display backlighting changes from green to red, so tolerance judgment can be made at a glance.
 > With RS-232C input/output

Stem dia. 3/8" #4-48 UNF Thread

Order No.	Resolution	Range	Model	Accuracy	List	Promo
543-562A	.00002", .00005", .0001", 0.0005mm, 0.001mm	1.2" / 30.4mm	ID-H530E	0.0015mm	\$1,040.00	\$936.00
543-564A	0.0005mm, 0.001mm	2.4" / 60.9mm	ID-H560E	0.0025mm	\$1,240.00	\$1,116.00

SPC cable – 1m: 936937 2m: 965014

10% OFF

21EZA099
Remote controller
(optional)



SPC

MeasurLink ENABLED
Data Management Software by Mitutoyo

ABSOLUTE Digimatic Indicator ID-U

> Slim digital indicator with low price.
 > Large LCD and simple key operation.
 > After the initial origin setting, the ID-U no longer needs absolute positioning over the entire battery life; the origin is remembered even after power-off.
 > Ideal for installation into measuring devices because of compact design and long battery life.
 > Employing the ABSOLUTE linear encoder, the ID-U always displays the spindle Absolute Position from the origin at power-on. Also unlimited response speed eliminates overspeed errors.
 > Flat-back type has no option for backs.

Order No.	Resolution	Range	Model	Accuracy	Measuring force	List	Promo
575-123	.0005"/0.01mm	1" / 25.4mm	ID-U1025E	.0008"	1.8N or less	\$230.00	\$207.00

SPC cable – 1m: 905338 2m: 905409

10% OFF



SPC

ABSOLUTE

MeasurLink ENABLED
Data Management Software by Mitutoyo

ABSOLUTE Digimatic Indicator ID-S

> Employing the ABSOLUTE linear encoder, the ID-S always displays the spindle Absolute Position from the origin at power-on. Also, unlimited response speed eliminates overspeed errors.
 > Dust/water protection level: IP42 (IP53: 543-796B-10).
 > SPC data output

10% OFF



SPC

ABSOLUTE

MeasurLink ENABLED
Data Management Software by Mitutoyo

Order No.	Resolution	Range	Accuracy	Measuring force	Remarks	List	Promo
Stem dia. 3/8", #4-48 UNF Thread							
543-792-10	.00005"/0.001mm	.5" / 12.7mm	±.0001"	1.5N or less	w/ lug back	\$322.00	\$289.80
543-796-10	.00005"/0.001mm	.5" / 12.7mm	±.0001"	2.5N or less	w/ flat-back	\$356.00	\$320.40
543-793-10	.0001"/0.001mm	.5" / 12.7mm	±.0001"	1.5N or less	w/ lug back	\$322.00	\$289.80
543-783-10	.0005"/0.01mm	.5" / 12.7mm	±.0010"	1.5N or less	w/ flat-back	\$209.00	\$188.10
543-792B-10	.00005"/0.001mm	.5" / 12.7mm	±.0001"	1.5N or less	w/ lug back	\$322.00	\$289.80
543-796B-10	.00005"/0.001mm	.5" / 12.7mm	±.0001"	2.5N or less	w/ flat-back	\$356.00	\$320.40
543-793B-10	.00005"/0.001mm	.5" / 12.7mm	±.0001"	1.5N or less	w/ lug back	\$322.00	\$289.80
543-783B-10	.0005"/0.01mm	.5" / 12.7mm	±.0010"	1.5N or less	w/ flat-back	\$209.00	\$188.10

Series Two Dial Indicators

- > Improved Impact- and oil-resistant materials are employed in the bezel. Easier reading is due to the improved shape of the crystal face.
- > High-strength, heat-treated stainless steel spindles for longevity
- > Scratch and chemical-resistant hard-coated crystals
- > Increased rigidity in the bearing plate for reducing the retracing error (20%) and 4-screw mounting for greater impact resistance
- > Inspection certificate included
- > No through screw-holes on the frame for high oil- and dust-resistance. The bezel clamp (optional) can be attached either to the right or left side.

10% OFF



2803A-10



2424A-19

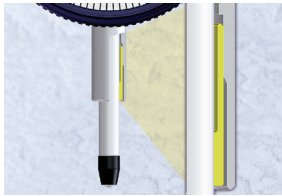

Revolutionary stem-bush design for trouble-free stem clamping (longer clamping range; maximum tightening torque at the clamping point with M5 screw: 150N•cm).

Order No.	Graduation	Range	Range/Rev	Type	Dial Reading	Accuracy First 2.5 Rev/ Overall	Force	List	Promo
2358A-10*	.0001"	.5"	.01"	w/lug	0-10	.0001 / .0008	2.0N or less	\$227.00	\$215.65
2803A-10*	.0001"	.025"	.01"	w/lug	0-5-0	.0001 / .0001	2.5N or less	\$189.00	\$179.55
2416A-10*	.001"	1"	.1"	w/lug	0-100	.001 / .002	1.8N or less	\$166.00	\$157.70
2424A-19*	.001"	2"	1"	w/lug	0-100	.001 / .003	2.5N or less	\$286.00	\$271.70
2776A	.0005"	1"	.05"	w/lug	0-50	.0005 / .002	2.5N or less	\$167.00	\$158.65

*Jeweled bearing model

Bore Gages

- > Carbide-tipped contact points for durability.
- > The dial indicator is fully protected by a rugged cover.
- > Optional extension rods can be attached for measuring deep holes.
- > The grip minimizes the variation of measurements by reducing heat transfer from the operator's hand



511-751-20

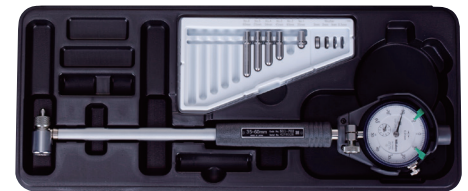

Order No.	Range	Graduation	Anvils	Spacers	List	Promo
With Indicator						
511-751-20	.7 - 1.4"	.0001" (2923B-10)	9	2	\$486.00	\$437.40
511-752-20	1.4 - 2.5"		6	4	\$473.00	\$425.70
511-753-20	2.0 - 6.0"		11 (2" sub anvil)	4	\$517.00	\$465.30
511-754-20	4.0 - 6.5"		13	4	\$683.00	\$614.70
511-755-20	6.5 - 10"		6	7	\$771.00	\$693.90
511-756-20	10 - 16"		5 (3" sub anvil)	7	\$915.00	\$823.50
Without Indicator						
511-731	.7 - 1.4"	Indicator optional Protective Cover optional (21DZA000)	9	2	\$309.00	\$278.10
511-732	1.4 - 2.5"		6	4	\$316.00	\$284.40
511-733	2.0 - 6.0"		11 (2" sub anvil)	4	\$342.00	\$307.80
511-734	4.0 - 6.5"		13	4	\$511.00	\$459.90
511-735	6.5 - 10"		6	7	\$599.00	\$539.10
511-736	10 - 16"		5 (3" sub anvil)	7	\$752.00	\$676.80

10% OFF



See Digimatic indicators made specifically for bore gages (page 6).

Holtest

- > Titanium-coated measuring pins provide excellent durability and impact resistance, while allowing the instrument to measure close to the bottom of blind holes.
- > Three-point design ensures self-centering action for stable measurements in the range above .275" bore diameter.
- > With ratchet stop for constant force.

Holtest Type II

- > Holtest Type II models are also available. These lower costs units have solid, hardened alloy steel anvils.

Mechanical Holtests – Individual Units

Order No.	Description/Range	List	Promo
368-021	Holtest, 0.08" - 0.1"	\$1,730.00	\$1,384.00
368-022	Holtest, 0.1" - 0.12"	\$1,730.00	\$1,384.00
368-023	Holtest, 0.12" - 0.16"	\$1,380.00	\$1,104.00
368-024	Holtest, 0.16" - 0.2"	\$1,380.00	\$1,104.00
368-025	Holtest, 0.2" - 0.24"	\$1,380.00	\$1,104.00
368-026	Holtest, 0.24" - 0.28"	\$1,380.00	\$1,104.00
368-261	Holtest, 0.275" - 0.35"	\$686.00	\$548.80
368-262	Holtest, 0.35" - 0.425"	\$686.00	\$548.80
368-263	Holtest, 0.425" - 0.5"	\$686.00	\$548.80
368-264	Holtest, 0.5" - 0.65"	\$712.00	\$569.60
368-265	Holtest, 0.65" - 0.8"	\$712.00	\$569.60
368-266	Holtest, 0.8" - 1.0"	\$739.00	\$591.20
368-267	Holtest, 1.0" - 1.2"	\$739.00	\$591.20
368-268	Holtest, 1.2" - 1.6"	\$924.00	\$739.20
368-269	Holtest, 1.6" - 2.0"	\$973.00	\$778.40
368-270	Holtest, 2.0" - 2.5"	\$980.00	\$784.00
368-271	Holtest, 2.5" - 3.0"	\$1,060.00	\$848.00
368-272	Holtest, 3.0" - 3.5"	\$1,090.00	\$872.00
368-273	Holtest, 3.5" - 4.0"	\$1,140.00	\$912.00
368-274	Holtest, 4.0" - 5.0"	\$1,470.00	\$1,176.00
368-275	Holtest, 5.0" - 6.0"	\$1,660.00	\$1,328.00
368-276	Holtest, 6.0" - 7.0"	\$1,710.00	\$1,368.00
368-277	Holtest, 7.0" - 8.0"	\$1,770.00	\$1,416.00
368-278	Holtest, 8.0" - 9.0"	\$2,000.00	\$1,600.00
368-279	Holtest, 9.0" - 10"	\$2,250.00	\$1,800.00
368-280	Holtest, 10" - 11"	\$2,270.00	\$1,816.00
368-281	Holtest, 11" - 12"	\$2,330.00	\$1,864.00

Mechanical Holtests – Complete Unit Sets

Order No.	Description/Range	List	Promo
368-916	Holtest, Set, 0.275" - 0.5"*	\$2,540.00	\$2,032.00
368-917	Holtest, Set, 0.5" - 0.8"*	\$1,710.00	\$1,368.00
368-918	Holtest, Set, 0.8" - 2.0"*	\$3,910.00	\$3,128.00
368-919	Holtest, Set, 2.0" - 4.0"*	\$5,560.00	\$4,448.00
368-920	Holtest, Set, 4.0" - 8.0"*	\$8,530.00	\$6,824.00
368-926	Holtest, 2pc Set, .08" - .12"*	\$3,660.00	\$2,928.00
368-927	Holtest, 4pc Set, .12" - .28"*	\$5,830.00	\$4,664.00

20% OFF

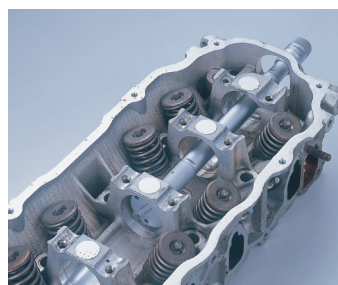
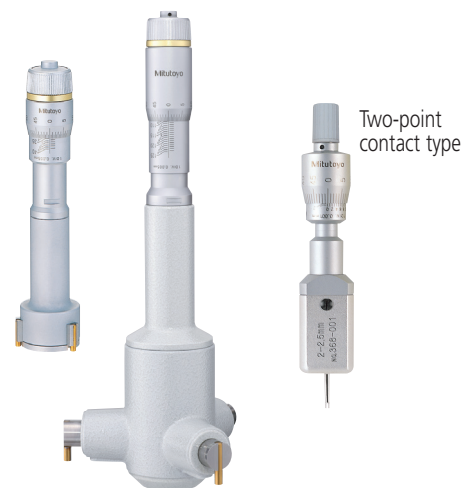

Measuring a Blind Hole

The measuring contact points held in the jaws permit measuring the diameter of a blind hole to the bottom. (up to 100mm / 4" models)

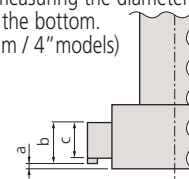

Range	a	b	c
6 - 12mm / .275 - .5"	2	—	2.5
12 - 20mm / .5 - .8"	0.3	5.6	3.5
20 - 30mm / .8 - 1.2"	0.3	8.3	5.2
30 - 50mm / 1.2 - 2"	0.3	13	10
50 - 100mm / 2 - 4"	0.3	17	14
100 - 300mm / 4 - 12"	12.4	21	13.8

Measuring Deep Holes

An extension tube (optional accessory) can be fitted to enable measurement of deep holes.



TiN coated contact points



Inspection Certificate Supplied as Standard

An Inspection Certificate is supplied with each instrument, which assures product quality and safety. On request, Mitutoyo can issue a Calibration Certificate, at a cost, from our accredited calibration laboratory.

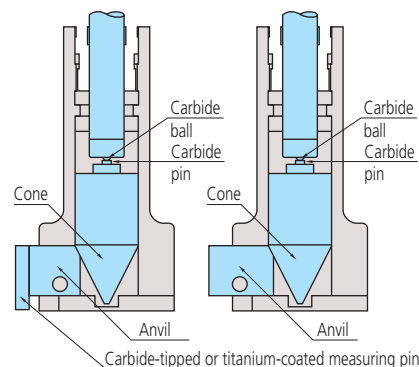

Digimatic Holtest

- > Titanium-coated measuring pins provide excellent durability and impact resistance, while allowing the instrument to measure close to the bottom of blind holes.
- > Large LCD readout.
- > Functions available: Presetting, Zero/ABS, Auto power On/Off, Data hold, Data output, Error alarm, Battery replacement alarm.
- > With ratchet stop for constant force.

- > Measure deep holes by attaching an extension rod (optional).
- > Setting rings are included in sets, but optional for individual gages.
- > Supplied in fitted plastic case up to 4"/100mm. Over 4"/100mm supplied in wooden case.
- > Resolution: .00005"/0.001mm (over 4" models: .0001"/0.001mm)

20% OFF



MeasurLink ENABLED
Data Management Software by Mitutoyo



Digimatic Holtests – Individual Units

Order No.	Range	List	Promo
468-261	Digimatic Holtest, .275 - .35"	\$1,280.00	\$1,024.00
468-262	Digimatic Holtest, .35" - .425"	\$1,280.00	\$1,024.00
468-263	Digimatic Holtest, .425 - .5"	\$1,290.00	\$1,032.00
468-264	Digimatic Holtest, 0.5" - 0.65"	\$1,390.00	\$1,112.00
468-265	Digimatic Holtest, 0.65" - 0.8"	\$1,390.00	\$1,112.00
468-266	Digimatic Holtest, 0.8" - 1"	\$1,440.00	\$1,152.00
468-267	Digimatic Holtest, 1.0 - 1.2"	\$1,440.00	\$1,152.00
468-268	Digimatic Holtest, 1.2" - 1.6"	\$1,470.00	\$1,176.00
468-269	Digimatic Holtest, 1.6" - 2.0"	\$1,480.00	\$1,184.00
468-270	Digimatic Holtest, 2" - 2.5"	\$1,610.00	\$1,288.00
468-271	Digimatic Holtest, 2.5" - 3"	\$1,610.00	\$1,288.00
468-272	Digimatic Holtest, 3" - 3.5"	\$1,630.00	\$1,304.00
468-273	Digimatic Holtest, 3.5" - 4"	\$1,650.00	\$1,320.00
468-274	Digimatic Holtest, 4" - 5"	\$2,150.00	\$1,720.00
468-275	Digimatic Holtest, 5" - 6"	\$2,220.00	\$1,776.00
468-276	Digimatic Holtest, 6" - 7"	\$2,350.00	\$1,880.00
468-277	Digimatic Holtest, 7" - 8"	\$2,440.00	\$1,952.00
468-278	Digimatic Holtest, 8" - 9"	\$2,620.00	\$2,096.00
468-279	Digimatic Holtest, 9" - 10"	\$2,670.00	\$2,136.00
468-280	Digimatic Holtest, 10" - 11"	\$2,770.00	\$2,216.00
468-281	Digimatic Holtest, 11" - 12"	\$2,880.00	\$2,304.00

Measuring Deep Holes

An extension rod (optional accessory) can be fitted to provide measurement of deep holes.

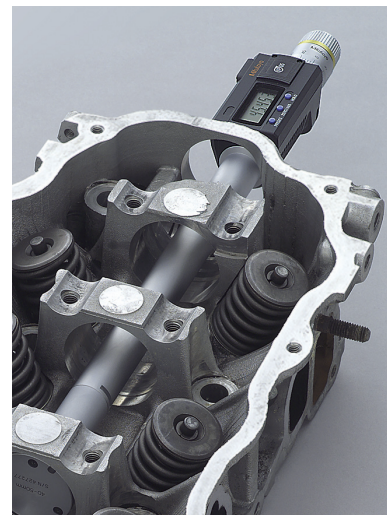

▶ SCAN ME

Digimatic Holtests – Interchangeable Head Sets

Order No.	Range	List	Promo
468-976	Digimatic Holtest Head Set, 0.275" - 0.5"*	\$2,330.00	\$1,864.00
468-977	Digimatic Holtest, Head Set, 0.5" - 0.8"*	\$1,890.00	\$1,512.00
468-978	Digimatic Holtest, Head Set, 0.8" - 2"*	\$4,720.00	\$3,776.00
468-979	Digimatic Holtest, Head Set, 2" - 4"*	\$5,410.00	\$4,328.00
468-980	Digimatic Holtest, Head Set, 4" - 8"*	\$6,350.00	\$5,080.00

Digimatic Holtests – Complete Unit Sets

Order No.	Range	List	Promo
468-986	Digimatic Holtest, Unit-Set, 0.275" - 0.5"*	\$4,530.00	\$3,624.00
468-987	Digimatic Holtest, Unit-Set, 0.5" - 1"*	\$4,820.00	\$3,856.00
468-988	Digimatic Holtest, Unit-Set, 1" - 2"*	\$5,460.00	\$4,368.00
468-989	Digimatic Holtest, Unit-Set, 2" - 3"*	\$6,130.00	\$4,904.00
468-990	Digimatic Holtest, Unit-Set, 3" - 4"*	\$7,210.00	\$5,768.00



Complete-Unit Set



Interchangeable-Head Set

Prices effective March 15, 2024 through June 28, 2024

Borematic

Quick, spring-loaded lever action/movement

- ▶ Titanium-coated measuring pins provide excellent durability and impact resistance, while allowing the instrument to measure close to the bottom of blind holes.
- ▶ Digital display with quick-action lever operation enables quick and easy measurement.
- ▶ Built-in ABSOLUTE System eliminates the need to set the origin point every time the unit is turned on. The system is immune to over-speed errors, thus increasing the reliability of measurement.
- ▶ The Digimatic Borematic is compatible with statistical process control systems and measurement support systems.
- ▶ Built-in tolerance judgment function allows GO/NO-GO judgment based on user-defined upper and lower limit settings.

**SAVE
20%**

MeasurLink ENABLED
Data Management Software by Mitutoyo

ABSOLUTE

SPC

Individual Gages: includes one digital display unit and one interchangeable measuring head (plus adapter if required)

Order No	Size Range	Accuracy	Extension Rod	List	Promo
568-461	0.275" - 0.350"	±5µm ±0.00025 in	100mm (952322)	\$1,660.00	\$1,328.00
568-462	0.350" - 0.425"			\$1,660.00	\$1,328.00
568-463	0.425" - 0.500"			\$1,660.00	\$1,328.00
568-464	0.50" - 0.65"	±5µm ±0.00025 in	150mm (952621)	\$1,700.00	\$1,360.00
568-465	0.65" - 0.80"			\$1,700.00	\$1,360.00
568-466	0.8" - 1.0"			\$1,700.00	\$1,360.00
568-467	1.0" - 1.2"	±6µm ±0.0003 in	150mm (952622)	\$1,760.00	\$1,408.00
568-468	1.2" - 1.6"			\$1,940.00	\$1,552.00
568-469	1.6" - 2.0"			\$1,940.00	\$1,552.00
568-470	2.0" - 2.5"		150mm (952623)	\$1,900.00	\$1,520.00
568-471	2.5" - 3.0"			\$1,970.00	\$1,576.00
568-472	3.0" - 3.5"			\$2,000.00	\$1,600.00
568-473	3.5" - 4.0"		\$2,000.00	\$1,600.00	
568-474	4.0" - 4.5"		\$2,100.00	\$1,680.00	
568-475	4.5" - 5.0"		\$2,220.00	\$1,776.00	



Technical Data

Resolution: 0.001mm or 0.00005 in/0.001mm

Display: LCD

Response speed: Infinite

Battery: SR44 (1 pc), **938882**, for initial operational checks (standard accessory)

Battery life: Approx. 5,000 hours in continuous use

Scale type: Electrostatic capacitance absolute encoder

Functions

GO/NO-GO judgment, GO/NO-GO judgment zoom, 2-Point Preset, Zero-setting, Data hold, Error alarm, Low battery voltage alert, Data output, Function Lock, 330° rotary display, inch/mm conversion (inch/mm models)

Complete Unit Gage Sets: includes several individual gages to cover the overall size range of the set

Order No	Overall Range	Range of Individual Gages	Setting Rings	List	Promo
568-965	0.275" - 0.5"	0.275-0.35", 0.35-0.425", 0.425-0.5"	0.35" DIA., 0.425" DIA.	\$5,750.00	\$4,600.00
568-966	0.5" - 1"	0.5-0.65", 0.65-0.8", 0.8-1"	0.65" DIA., 0.8" DIA.	\$5,990.00	\$4,792.00
568-967	1" - 2"	1-1.2", 1.2-1.6", 1.6-2"	1.2" DIA., 1.6" DIA.	\$6,260.00	\$5,008.00
568-968	2" - 3"	2-2.5", 2.5-3"	2.5" DIA.	\$4,480.00	\$3,584.00
568-969	3" - 4"	3-3.5", 3.5-4"	3.5" DIA.	\$4,970.00	\$3,976.00



Interchangeable-Head Sets

Order No	Overall Range	Range of Individual Gages	Setting Rings	List	Promo
568-928	0.275" - 0.5"	0.275-0.35", 0.35-0.425", 0.425-0.5"	0.35" DIA., 0.425" DIA.	\$2,560.00	\$2,048.00
568-929	0.5" - 1"	0.5-0.65", 0.65-0.8", 0.8-1"	0.65" DIA., 0.8" DIA.	\$2,890.00	\$2,312.00
568-930	1" - 2"	1-1.2", 1.2-1.6", 1.6-2"	1.2" DIA., 1.6" DIA.	\$3,540.00	\$2,832.00
568-936	2" - 4"	2-2.5", 2.5-3", 3-3.5", 3.5-4"	2.5" DIA., 3.5" DIA.	\$5,090.00	\$4,072.00



Includes one digital display unit with several interchangeable measuring heads (and adapters as required) to cover the total size range plus one extension rod

PH-3515F Profile Projector and 2D Processor Packages
Heavy-Duty, Bench-Top Model with Horizontal Optical System featuring touch screen M2 geometric measuring display

- > ø14" screen, Horizontal Projector
- > 10" x 6" Travel T Slot table for accessories
- > Linear Glass Scales for accurate measurement
- > Profile and Fiber Optic Surface Illumination
- > Digital built-in angle counter
- > Maximum Load 45 kg / 100lb
- > Available with M2 or QM Data 2D Processors

Order No.	Description	List	Promo
PH-3515 Main Unit & Digital Readout Packages 5% Off			
64PKA089B	PH-3515F Profile Projector with KA counter & Tray	\$13,300.00	\$12,635.00
64PKA088A	PH-3515F Profile Projector with QM Data & Arm Mount	\$15,400.00	\$14,630.00
64PKA166	PH-3515F Profile Projector with Touchscreen PC & M2 Software/Hardware	\$16,600.00	\$15,770.00
64PKA165	PH-3515F Profile Projector with Optical Edge Detection, Touchscreen PC & M2 Software/Hardware	\$18,200.00	\$17,290.00
Machine Stand (Optional)			
64AAB176	PH-3515F Stand (optional add-on)	\$787.00	\$787.00

(Includes installation and A2LA accredited calibration)

5% OFF 5% off all Main Units

5% OFF 5% off all Packages

FREE SHIPPING Free Shipping

Installation & Calibration Included

64PKA166
 PH-3515 Profile Projector, M2 Software/ Hardware and All-In-One Touchscreen PC



KA-200 Counter: PH-3515 & PV-5110

MeasurLink ENABLED
 Data Management Software by Mitutoyo



Display unit for X & Y Linear Scales

- > ABSOLUTE and incremental modes (10 presets each)
- > 0.05-.0001mm / .02" - .000005" in resolution
- > Calculator functionality

Compatible Digital-Read-Out (DRO) Devices

M2 Software & Hardware: PH-3515 & PJ-PLUS

M2 is a universal 2D coordinate measurement software which has become the preferred software for many optical comparator users due to its intuitive user interface and data collection procedures.

- > Software & All-In-One Touch Screen PC Included
- > Full Integration and A2LA Calibration conducted

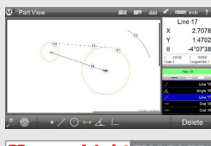

MeasurLink ENABLED
 Data Management Software by Mitutoyo

Automatic Edge Detection



- Fiber Optic Edge Detection system integrated into M2 software via M2 Communication Unit.
- Intuitive Edge Teach Functionality built into software.
- Allows for continuous measurement of features, while storing data for post process analysis

PJ-Plus with M2 2D Processor Packages

The PJ-Plus is a new series of profile projector offered by Mitutoyo. This system utilizes LED lighting and a fan-less design making it ideal for harsh manufacturing facilities or job shop.

Order No	Description	XY Stage	List	Promo
PJ-PLUS Main Units - 5% Off				
302-801-10A	PJ-P1010A 4x4"/100x100m	4x4"/100x100m	\$12,400.00	\$11,780.00
302-802-10A	PJ-P2010A 8X4"/200x200mm	8X4"/200x200mm	\$15,500.00	\$14,725.00
PJ-PLUS & M2 Packages - 5% Off				
302-801-10PKA1	PJ-PLUS 4X4 - M2, Optical Edge Detection and Touchscreen	4x4"/100x100mm	\$18,700.00	\$17,650.00
302-801-10PKA2	PJ-PLUS 4x4 - M2 and Touchscreen PC Package	4x4"/100x100mm	\$17,300.00	\$16,435.00
302-802-10PKA1	PJ-PLUS 8x4 - M2, Optical Edge Detection and Touchscreen	8x4"/200x100mm	\$21,900.00	\$20,805.00
302-802-10PKA2	PJ-PLUS 8x4 - M2 and Touchscreen PC Package	8x4"/200x100mm	\$20,500.00	\$19,475.00
Machine Stand (Optional)				
172-269	Machine Stand for PJ Series		\$1,900.00	\$1,900.00

5% OFF 5% off all Main Units

5% OFF 5% off all Accessory Packages

FREE SHIPPING Free Shipping

Installation & Calibration Included

302-801-10A-M2-EDGE

MeasurLink ENABLED
 Data Management Software by Mitutoyo

An XY axis digital counter is built into the PJ-Plus



Prices effective March 15, 2024 through June 28, 2024

PV-5110 Vertical (Downward) Profile Projector (5% OFF Main Unit & 5% OFF DRO)

The PV-5110 Profile Projector is a downward optical axis projector fitted with stable glass stage for delicate item inspection, ensuring accuracy and preventing damage. Its advanced optics and secure platform make it an optimal choice for precise applications, particularly with thin or delicate workpieces.

- > ø19.4" screen, Vertical Projector
- > Downward Optical Axis - Provides improved oblique surface illumination
- > LED illumination
- > Built-In Dual Oblique Surface Illumination for improved contrast.

Order No.	Description	List	Promo
PV-5110 Main Unit & Digital Readout Interface Packages - 5% Off			
304-919-11A-KA	PV-5110 with KA Counter	\$23,197.00	\$22,037.15
304-919-11A-QM	PV-5110 with QM Data	\$25,584.00	\$24,304.99
304-919-11A-QM-OPT	PV-5110 with QM Data and OPTOEYE	\$27,541.20	\$26,164.14

No stand or elevated surface required*

5% OFF 5% off all Main Units



5% OFF 5% off all Packages



FREE SHIPPING Free Shipping



Installation & Calibration Included



304-919-11A-KA
PV-5110 with KA Counter

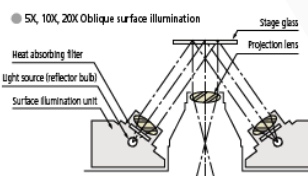

Additional DRO

QM Data: PH-3515, PJ-PLUS, PV-5110 & PJ-H30



The QM-Data200 unit features the powerful QM 2D coordinate measurement software pre-loaded onto our rugged user interface. The QMData200 interface features easy-to-use key operations and allows for measurement results to be visualized on its LCD Display.

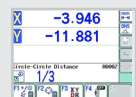

Plot Single Data Points



Return 2-Dimensional Graphic and Calculated Values

- > Built-In Guided Measurement Tutorials
- > Programmable Measurement Procedures & Calculations
- > Data Collection and USB Output
- > Full Integration and A2LA Calibration conducted by Mitutoyo Field Service team.

MeasurLink ENABLED
Data Management Software by Mitutoyo

Optoeye-200

Optical Edge Detection (Additional Purchase Required)



PJ-H30 Vertical Profile Projector

The Mitutoyo PJ-H30 is unique given its ability to produce an uninverted image, which improves the intuitive operation as the projected image appears in the same orientation as the workpiece.

- > Newly designed optical system with high NA lenses provides drastically brighter and clearer screen images
- > The three-lens mounting turret includes a 10X lens as standard
- > Built-In digital XY Counter
- > Available with QM Data 2D processor & Optical Edge Detection

Order No.	Description	XY Travel	List	Promo
PJ-H30 Main Units - 25% OFF				
303-716-13A	PJ-H30A1010B	4x4"/100x100mm	\$26,500.00	\$19,875.00
303-717-13A	PJ-H30A2010B	8x4"/200x100mm	\$32,300.00	\$24,225.00
303-718-13A	PJ-H30A2017B	8x6.7"/200x170mm	\$38,200.00	\$28,650.00
303-719-13A	PJ-H310A3017B	12x6.7"/300x170mm	\$44,100.00	\$33,075.00
Digital Readout Interface (Add-On Packages - Optional) - 5% Off				
264-156A-PJH	QM-DATA200 Arm Type (PJ-H Series Package)		\$4,137.20	\$3,930.34
264-156A-PJH-OPT	QM-DATA200 Arm Type & Optoeye (PJ-H)		\$6,156.15	\$5,848.34
Machine Stand (Optional)				
172-269	Machine Stand for PJ Series		\$1,900.00	\$1,900.00

25% OFF 25% off all Main Units



5% OFF 5% off all Accessory Packages



FREE SHIPPING Free Shipping



Installation & Calibration Included

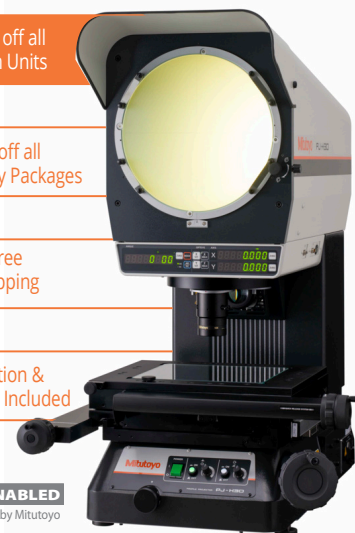

303-716-13A PJ-H30A3017B

MeasurLink ENABLED
Data Management Software by Mitutoyo



High-Accuracy Height Gage Linear Height LH-600F/FG

The highest accuracy height gage on the market is now even easier to use.

The Mitutoyo LH-600F Linear Height Measurement System is the latest model in the Mitutoyo Linear Height Gage line, designed to be more user-friendly while maintaining the best-in-class reliability and accuracy of previous models.

New Features:

- > Rotatable touch screen interface
- > New self-check feature
- > High-accuracy encoder more resistant to contaminants
- > Improved 2D mode
- > Calibration date warning
- > S1 Digimatic output capable of sending data directly to Excel, wired or wirelessly
- > Additional probe and extension options

Still Featuring:

- > Resolution down to 0.1µinch (selectable)
- > Highest accuracy in its class $\pm (1.1+0.6L/600) \mu\text{m}$
- > Pneumatic full/semi-float system with built-in compressor
- > Capable of standard measurements such as heights and diameters or advanced measurements like angles, diagonal distances and perpendicularity (optional probes may be required)
- > The Origin can be set at centerline positions, peaks of radii or simply on the surface plate or gage blocks



Perpendicular/straightness measurement - Graph creation

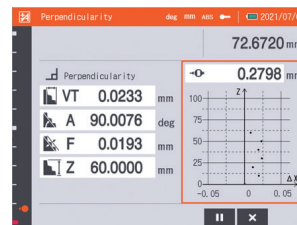

Show results in real time during measurement.

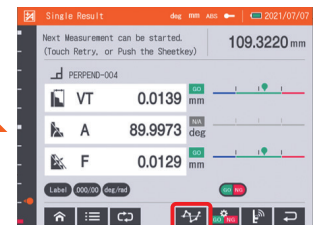

Show results after measurement.

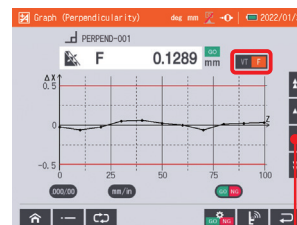

You can monitor the graphs of past measurement results.

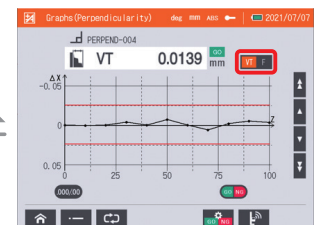

Show measurement results in graph form.

Order No	Description	Range (Stroke)	Resolution (selectable)	Promo
Promo030	LH-600F INCH/MM	977mm (600mm) / 38" (24")	0.0001/0.001/0.01/0.1mm .0000001/.000001/.00001/.0001"	\$9,360.00
Promo031	LH-600FG Inch/mm, Power Grip model			\$9,810.00

Prices effective March 15, 2024 through June 28, 2024

Easy operation using keypad and touch screen navigation

Contextual guidance on the large-screen touch panel supports your measurements.



Simple, straightforward keys with icons

Icons allow the user to find the required operation at a glance.

Basic measurements



Height (top) measurement



Height (bottom) measurement



Width (inside) measurement



Width (outside) measurement



Shaft (top) measurement



Shaft (bottom) measurement



Circle (shaft) measurement



Max.-Min. (top) measurement



Hole (bottom) measurement



Hole (top) measurement



Circle (hole) measurement



Max.-Min. (bottom) measurement

Advanced measurement functions



Part program measurement



2D measurement

Power



Power

Measurement settings



Measurement origin setting



Probe selection



Measurement origin switching

Other



Home screen



System settings



Data output

Touch panel with guidance

Measurement guidance is displayed on the large touch panel of the 8.4-inch color LCD, enabling intuitive operation.



Guidance screen



Operable with gloves

Expanded measurement area

With the new optional probes, you can now measure areas that were beyond the capacity of conventional probes.

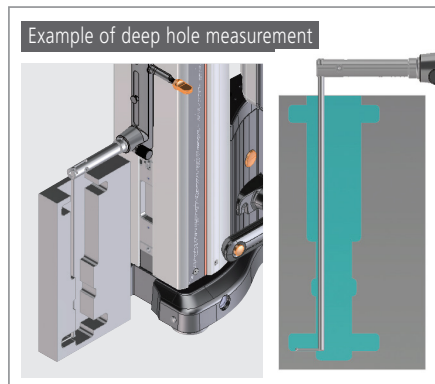
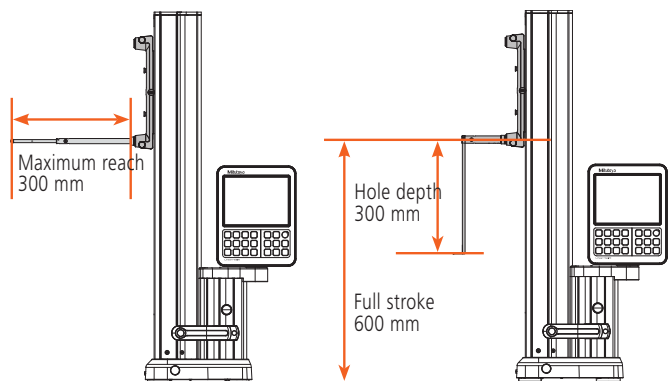

To see full brochure,
use the QR code below.



SCAN ME

ABSOLUTE 1D Height Gage QM-Height Series

- > High-resolution ABSOLUTE linear encoder for position detection
- > High-accuracy: $\pm(2.4 + 2.1L / 600)\mu\text{m}$
- > Pneumatic flotation system / positioning grip allows for smooth movement along surface plate (select models)
- > Large, stationary display panel with user-friendly icon control keys and GO/NO-GO LED indicator
- > Digital and USB output: Supports Mitutoyo wireless SPC output
- > Fully compatible with existing Mitutoyo Digimatic peripherals (SPC cables, U-WAVE wireless transmitters, multiplexers, etc.)
- > **Battery life of 1200 hours in continuous use with four AA batteries, an improvement from 300 hours.**

GO/ \pm NG judgment by LED (red, orange, green) and measurement examples

- > LEDs are activated at the time of tolerance judgment: green for GO, red for +NG, and orange for -NG. -NG, GO and +NG also appear on the LCD.



"d2" is the name for Mitutoyo Digimatic output compatible with up to 8 digits of I/O data.

MeasurLink ENABLED
Data Management Software by Mitutoyo

d2 Digimatic and USB outputs

- Digimatic and USB ports are provided as standard. Using the U-WAVE-T measurement data wireless communication system enables instant transmission of measurement data to a PC via wireless communication which reduces manual input errors and improves data reliability and operational efficiency.



To install **U-WAVE-T**, separately purchase the optional mounting plate (**02AZE990**).



- > Measure diameters, gap distances, center-to-center distances, and more
- > Sub-display can show difference between current and previous measurement or distance from current measurement to origin
- > The origin can be set at the top of a surface plate, centerline, or any top or bottom surface within its range

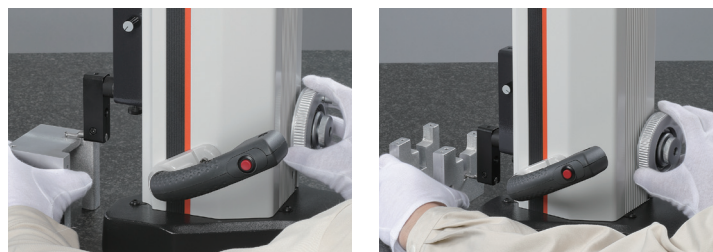

Measurement Examples

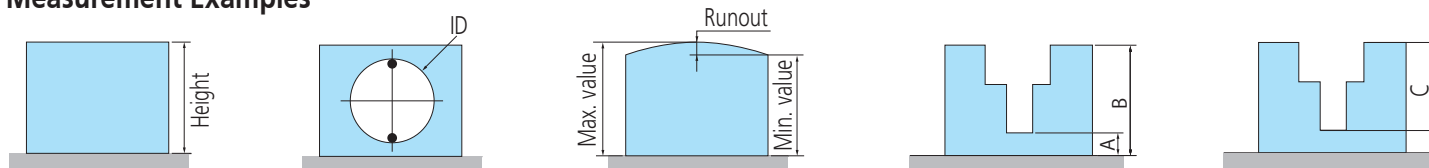

Part No.	Range	Resolution	Remarks	List	Promo
64PKA094C	0 - 14" / 0 - 350mm	0.001mm / 0.0005mm / .00005" / .0001" (selectable)	Pneumatic Flotation System	\$4,580.00	\$4,122.00
64PKA095C	0 - 24" / 0 - 600mm			\$5,150.00	\$4,635.00
64PKA129C	0 - 14" / 0 - 350mm			\$5,150.00	\$4,635.00
64PKA130C	0 - 24" / 0 - 600mm			\$5,710.00	\$5,139.00

Optional Accessories

Order No.	Description	List	Promo
12AAC072	DEPTH PROBE	\$227.00	\$215.65
12AAA837	INDICATOR HOLDER (ACCEPTS 3/8" STEM)	\$159.00	\$151.05
12AAA793	PROBE EXTENSION HOLDER (3.3" / 85mm)	\$184.00	\$174.80
226118	SHANK WITH M3 THREAD SCREW	\$145.00	\$137.75
957265	20MM DIA. DISK STYLUS FOR LINEAR HEIGHT	\$437.00	\$415.15
957264	14MM DIA. DISK STYLUS FOR LINEAR HEIGHT	\$342.00	\$307.80
12AAF669	10PI BALL CONTACT POINT(COAXIAL)	\$269.00	\$255.55
957261	2MM DIA. BALL STYLUS FOR LINEAR HEIGHT	\$241.00	\$228.95
517-814-10	GRAPLATE 36X48" GRADE A	\$3,200.00	\$3,040.00
517-964-10	GRAPLATE STAND 36X48"	\$1,260.00	\$1,197.00
517-808-10	GRAPLATE 24X36" GRADE A	\$1,670.00	\$1,586.50
517-956-10	GRAPLATE STAND 24X36"	\$1,170.00	\$1,111.50
06AFM380D	USB-ITN-D INPUT TOOL DIRECT CABLE	\$226.00	\$214.70
02AZD730G-D	U-WAVE TRANSMITTER W/ CONNECTING CABLE (D)	\$378.00	\$359.10
02AZD810D	U-WAVE-RECEIVER	\$571.00	\$542.45

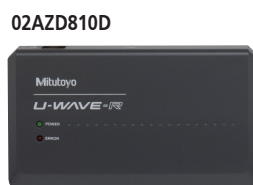
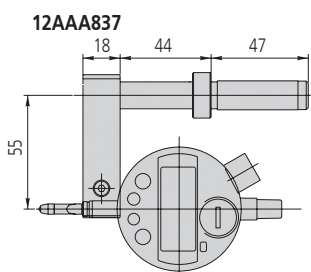

Coolant-Proof Calipers

- > Sealed housing is IP-67 rated, meaning it's immune to the coolants, dirt, grit and chips found in many manufacturing environments.
- > Easy to use - no need to wipe or clean the scale.
- > .0005"/0.01mm resolution with ±.001" accuracy.
- > Automatic power-on/off.
- > Certificate of Inspection provided.

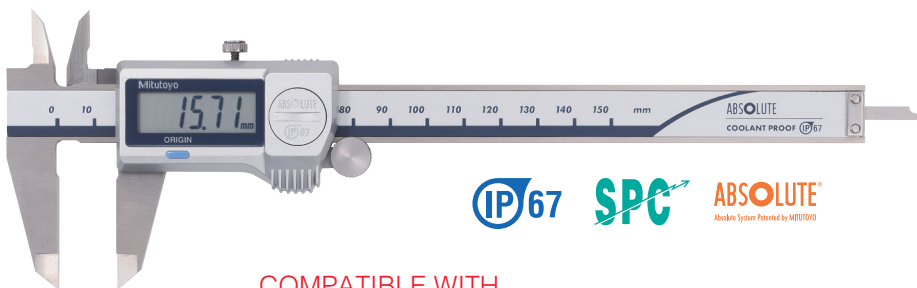

COMPATIBLE WITH
U-WAVE fit

MeasurLink ENABLED
Data Management Software by Mitutoyo

Order No.	Range	List	Promo
Non-Output Style			
500-752-20	0-6"/0-150mm	\$246.00	\$233.70
500-753-20	0-8"/0-200mm	\$330.00	\$313.50
500-754-20	0-12"/0-300mm	\$571.00	\$542.45
SPC Output Style			
fit 500-762-20	0-6"/0-150mm	\$292.00	\$277.40
fit 500-763-20	0-8"/0-200mm	\$368.00	\$349.60
fit 500-764-20	0-12"/0-300mm	\$634.00	\$602.30

* ±.0015" accuracy **fit** U-WAVE Fit compatible SPC cable – 1m: **05CZA624** 2m: **05CZA625**



COOLANT PROOF™ IP67

COOLANTPROOF is the universal term of Mitutoyo Digimatic Small Tool Instruments that are free from measurement error and physical deterioration due to routine exposure to water, cutting oil or coolant. This high performance is achieved by using encoders that are inherently immune to contamination, where exposure is inevitable, combined with comprehensive sealing techniques and extremely oil-resistant materials to guarantee a long working life under normal operating conditions.

Digimatic Carbon Fiber Caliper

10% OFF



Order No.	Range	Accuracy	Resolution	List	Promo
552-312-10	0(.5")-18"	+/- .002"	.0005"/0.01mm	\$1,110.00	\$1,054.50
552-313-10	0(.5")-24"	+/- .002"	.0005"/0.01mm	\$1,250.00	\$1,187.50
552-314-10	0(1")-40"	+/- .002"	.0005"/0.01mm	\$2,240.00	\$2,128.00
552-315-10	0(1")-60"	+/- .004"	.0005"/0.01mm	\$2,670.00	\$2,536.50
552-316-10	0(1")-80"	+/- .005"	.0005"/0.01mm	\$4,180.00	\$3,971.00

SPC cable – 1m: **05CZA624** 2m: **05CZA625**

- > Lightweight Digimatic Calipers that employ CFRP (Carbon Fiber Reinforced Plastics) in the beam and jaws.
- > Highly durable and easy to handle.
- > Direct readout of ID measurements from the LCD. (Offset value can be set easily by pressing the Offset key.)
- > Preset function for setting a desired starting point.
- > With SPC data output.
- > Special models available with ceramic jaws which are suitable for measuring abrasive and magnetic products.
- > Can be used in workshop conditions exposed to coolant, water, dust or oil.
- > Incorporates ABSOLUTE measurement system.
- > Automatic power-on/off.



CERA Caliper Checker



33% OFF

Order No.	Range	Remarks (length to check)	List	Promo
515-565	0 - 12"	Outside measurement: 1", 2", 4", 6", 8", 10", 12" Inside measurement: 1", 2", 4", 6", 8", 10", 12"	\$5,180.00	\$3,470.60

Prices effective March 15, 2024 through June 28, 2024

CERA Caliper Checker

- > Permanently wrung, high grade CERA gage blocks in a protective metal casing.
- > Stands perpendicular for height gage inspection.

* Also includes same features as CERA Gage Blocks

CERA (Zirconia Ceramic) Gage Blocks*

- > Extremely high wear resistance, 3x better than carbide.
- > Corrosion proof – no oil needed.
- > Closest expansion coefficient to steel.
- > Anti-magnetic – keeps away steel dust.
- > High wringing force due to high density.
- > Crack and burr resistant.
- > Low thermal conductivity – excellent dimensional stability under brief temperature changes (from handling, etc.).

Digimatic Calipers

- > AOS Electromagnetic inductive sensor improves environmental resistance against dirt, water and oil.
- > A battery life of approximately 3.5 years has been achieved under normal use through the adoption of Mitutoyo's ABSOLUTE scale.
- > The slider configuration features an ergonomic, thumb-friendly shape.
- > Step-measurement capable.
- > The data output function allows integration into Statistical Process Control and measurement systems.
- > Display character height: 9mm
- > AOS applies to 4", 6" and 8" models
- > Resolution: .0005"/0.01mm

MeasurLink ENABLED
Data Management Software by Mitutoyo



500-171-30



AOS: Advanced Onsite Sensor

Order No.	Range	Remarks	List	Promo
No SPC Output Style				
500-195-30	0-4"/0-100mm	.075" round depth bar	\$170.00	\$161.50
500-196-30	0-6"/0-150mm		\$184.00	\$174.80
500-197-30	0-8"/0-200mm		\$265.00	\$251.75
500-193-30	0-12"/0-300mm		\$532.00	\$505.40
With SPC Output Style				
fit 500-170-30	0-4"/0-100mm	.075" round depth bar	\$203.00	\$192.85
fit 500-171-30	0-6"/0-150mm		\$215.00	\$204.25
500-172-30	0-8"/0-200mm		\$284.00	\$269.80
500-173-30	0-12"/0-300mm		\$621.00	\$589.95
500-505-10	0-18"/0-450mm	without thumb roller	\$967.00	\$918.65
500-506-10	0-24"/0-600mm	without thumb roller	\$1,060.00	\$1,007.00
500-507-10	0-40"/0-1000mm	without thumb roller	\$2,050.00	\$1,947.50

fit U-WAVE Fit compatible

SPC cable with data switch – 1m: 959149 2m: 959150

Dial Caliper

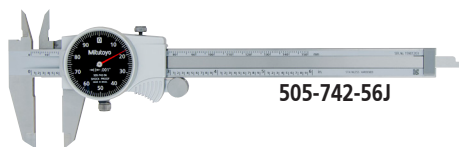

505-742-56J

- > Smooth sliding with high shock protection.
- > Lock screw for dial bezel and for holding the sliding jaw position.
- > Can measure OD, ID, depth and steps.
- > Models available with carbide-tipped OD and ID jaws.

Order No.	Range	Remarks	List	Promo
505-742J	0-6" .100"/rev		\$149.00	\$141.55
505-738J	0-6" .100"/rev	carbide-tipped jaws	\$243.00	\$230.85
505-740J	0-6" .200"/rev		\$136.00	\$129.20
505-743J	0-8" .100"/rev		\$217.00	\$206.15
505-746J	0-12" .100"/rev		\$331.00	\$314.45
505-749J	0-12" .200"/rev		\$309.00	\$293.55
505-742-56J	0-6" .100"/rev	black dial face	\$149.00	\$141.55

Offset Caliper

- > Main scale jaw can slide up and down to facilitate measurement of stepped sections. (Hard-to-reach dimensions such as A, B, C can be accurately measured.)
- > With depth bar.
- > With SPC data output.

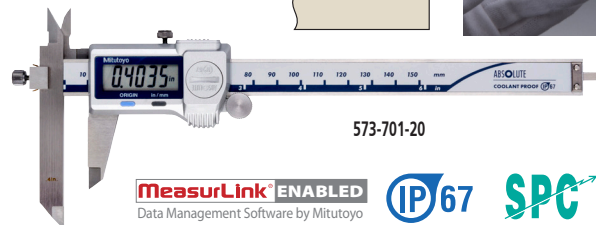
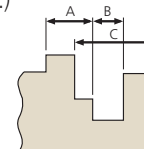

573-701-20

MeasurLink ENABLED
Data Management Software by Mitutoyo



Order No.	Range	Accuracy	Resolution	List	Promo
fit 573-701-20	0-6" / 0-150mm	±.001"	.0005" / 0.01mm	\$548.00	\$520.60
fit 573-702-20	0-8" / 0-200mm	±.001"	.0005" / 0.01mm	\$628.00	\$596.60
fit 573-704-20	0-12" / 0-300mm	±.0015"	.0005" / 0.01mm	\$841.00	\$798.95

fit U-WAVE Fit compatible

SPC cable with data switch – 1m: 05CZA624 2m: 05CZA625

Point Caliper

- > Narrow tip jaws fit into very small grooves and tracks, making many previously difficult outside measurements easier to achieve.
- > With depth bar.
- > With SPC data output.

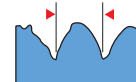

Random point-to-point dimensions

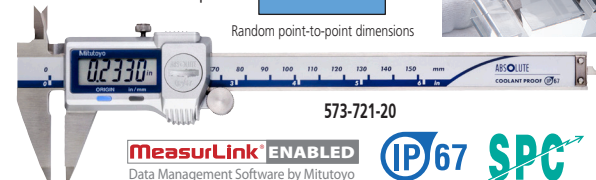
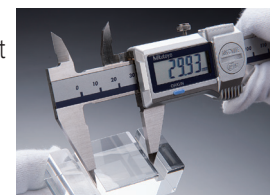

573-721-20

MeasurLink ENABLED
Data Management Software by Mitutoyo



Order No.	Range	Accuracy	Resolution	List	Promo
fit 573-721-20	0-6" / 0-150mm	±.001"	.0005" / 0.01mm	\$479.00	\$455.05
fit 573-725-20*	0-6" / 0-150mm	±.001"	.0005" / 0.01mm	\$596.00	\$566.20

* Extended tips **fit** U-WAVE Fit compatible SPC cable with data switch – 1m: 05CZA624 2m: 05CZA625

Low-Force Caliper

- > Due to the low measuring force, these calipers are ideal for elastic or resilient workpieces such as plastic parts and rubber parts that standard calipers can't measure consistently.
- > With SPC data output.

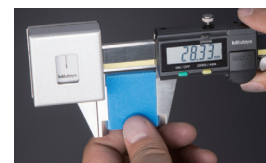

573-291-30

MeasurLink ENABLED
Data Management Software by Mitutoyo



Order No.	Range	Accuracy	Resolution	List	Promo
fit 573-291-30	0-7" / 0-180mm	±.002"	.0005" / 0.01mm	\$968.00	\$919.60

fit U-WAVE Fit compatible

www.mitutoyo.com

Quickmikes

The new Quickmike series still boasts the super-fast spindle feed rate that's **20x faster** than standard micrometers.

- > IP65 protection – can be used around cutting fluids
- > MIN Hold – the minimum measurement can be held on the display for more repeatable and accurate measurements
- > Larger LCD – 33% larger, 10mm character height
- > Function lock – prevents accidental changes
- > 5 year battery life – more operating time, less downtime looking for and replacing batteries
- > Non-rotating spindle



293-676-20

MeasurLink ENABLED
Data Management Software by Mitutoyo

COOLANT PROOF™ IP65



Order No.	Range	Resolution	Accuracy	Flatness	Parallelism	List	Promo
293-676-20	0 - 1.2"	.00005"/0.001mm	±0.0001"	0.000012"	0.00008"	\$700.00	\$665.00
293-677-20	1 - 2.2"	.00005"/0.001mm	±0.0001"	0.000012"	0.00008"	\$764.00	\$725.80

SPC cable with data switch – 1m: 05CZA662 2m: 05CZA663

MDC-Lite Micrometer

- > Provided only with zero set and in/mm (inch/metric models only) keys.
- > A ratchet stop or friction thimble for a constant measuring force.
- > Measurement readout with large characters on the LCD.
- > No spindle clamp. No data output.

Order No.	Range	Resolution	Remarks	List	Promo
293-831-30	0 - 1" / 0 - 25.4mm	.00005" / 0.001mm	Ratchet Stop	\$178.00	\$169.10
293-832-30	0 - 1" / 0 - 25.4mm	.00005" / 0.001mm	Friction Thimble	\$189.00	\$179.55



293-831-30

Digimatic Micrometer

- > New electromagnetic ABSOLUTE sensor - Improved resistance to environmental conditions such as dirt, oil and water, which can cause false readings.
- > New ratchet thimble on select models improves one-hand operability.
- > New anti-slip finish for improved grip while taking measurements.
- > Long battery life – 2.4 years under normal operation.
- > Fully compatible with existing Mitutoyo Digimatic peripherals (SPC Cables, U-WAVE wireless transmitters, DP1-VA, etc.) – SPC output-enabled IP65 models.
- > Function-lock system prevents inadvertent setting changes.
- > Certificate of Inspection provided.



COOLANT PROOF™



293-330-30



MeasurLink ENABLED
Data Management Software by Mitutoyo

Order No.	Range	Resolution	Remarks	List	Promo
fit 293-330-30*	0-1"/0-25.4mm	.00005"/0.001mm	Ratchet Stop	\$283.00	\$268.85
293-340-30	0-1"/0-25.4mm	.00005"/0.001mm	Ratchet Stop	\$260.00	\$247.00
293-344-30	0-1"/0-25.4mm	.00005"/0.001mm	Ratchet Thimble	\$260.00	\$247.00
293-349-30	0-1"/0-25.4mm	.0001"/0.001mm	Ratchet Thimble, tenths reading	\$260.00	\$247.00
fit 293-331-30*	1-2"/25.4-50.8mm	.00005"/0.001mm	Ratchet Stop w/Standard	\$333.00	\$316.35
293-341-30	1-2"/25.4-50.8mm	.00005"/0.001mm	Ratchet Stop w/Standard	\$286.00	\$271.70
293-345-30	1-2"/25.4-50.8mm	.00005"/0.001mm	Ratchet Thimble w/Standard	\$286.00	\$271.70
fit 293-334-30*	0-1"/0-25.4mm	.00005"/0.001mm	Ratchet Thimble	\$304.00	\$288.80
fit 293-335-30*	0-1"/0-25.4mm	.00005"/0.001mm	Friction Thimble	\$283.00	\$268.85

*with SPC Output

fit U-WAVE Fit compatible

SPC cable with data switch – 1m: 05CZA662 2m: 05CZA663



Purchase the world's first 5μinch /0.1μm resolution micrometer and receive a USB input tool and cable (\$300 value)

Using precision digital measuring tools together with a USB input tool improves both measurement results and data reliability. The high-accuracy MDH with 5 millionths resolution can output in its entirety in both inch and metric. Resulting data can input directly to Excel®, MeasurLink® or other SPC programs.

> Range: 0-1", Resolution: .000005", Accuracy: +/- .000020

Part No.	Description	List Price
PROMO029	Package: MDH Mic, SPC Cable, USB Input Tool	\$1,920.00
293-130-10	MDH Micrometer with high accuracy, high resolution output	\$1,920.00
05CZA662	SPC CONNECTING CABLE (1M)	\$96.05
264-020	USB INPUT TOOL	\$226.00



293-130-10



264-020



05CZA662

Package

MeasurLink ENABLED
Data Management Software by Mitutoyo

Absolute Digimatic Height Gages

Mitutoyo's popular, single beam height gages have been redesigned to be even easier to use, with larger displays, various hardware accessories, and multiple data options such as wired and wireless output, data loggers and more.

Features:

- > Durable Build - Iron detector and base, steel beam and holder
- > Easy to use slider feed wheel
- > Multiple data equipment options
- > Other improvements: twist-off battery cap, 20% larger LCD, handy Data button



Shown with optional Test Indicator and mounting hardware (see page 5).



Shown with optional U-Wave Bluetooth transmitter (see page 22 and connector 02AZD790F)



570-412

MeasurLink ENABLED
Data Management Software by Mitutoyo



Order No.	Range	Resolution	Functions	Drive Method	Data Output	Max. response speed	Battery Life	List	Promo
570-412	0"-12"/0mm-300mm	0.0005" / 0/01mm	On/Off, Origin, Zero/ABS, Hold/Data, inch/mm conversion"	Slider-feed wheel (manual)	Digimatic d1	Unlimited	Approx. 5 years under normal use	\$860.00	\$817.00
570-413	0"-18"/0mm-450mm							\$1,150.00	\$1,092.50
570-414	0"-24"/0mm-600mm							\$1,340.00	\$1,273.00

U-WAVE is a wireless system that turns any Mitutoyo gage with Digimatic output into a wireless keyboard for fast, error-free data collection. U-WAVE transmitters now come in three models: Bluetooth®, Fit and Standard. Send data with a push of a button or request it from the PC or mobile device.



U-WAVE Bluetooth®

U-WAVE-TMB/TCB

The new U-WAVE Bluetooth® transmitter features:

- Now utilizes the popular Bluetooth® 4.2 Low Energy Wireless Technology.
- This new Bluetooth® version of U-WAVE allows a simple connection to smartphones, tablets and Bluetooth® enabled Laptops and PC's.
- The same low profile and ergonomic fit benefits of the U-WAVE Fit.
- A buzzer type and IP67 type with dustproof and waterproof specifications are available.
- Up to 7 units can be connected to 1 Bluetooth® enabled PC without a receiver.
- New U-WAVEPak for Android, iOS and Windows available at no cost.



Request an assessment to determine how quickly your company can obtain a full ROI

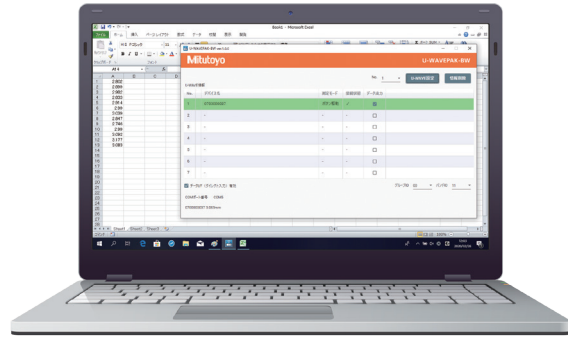
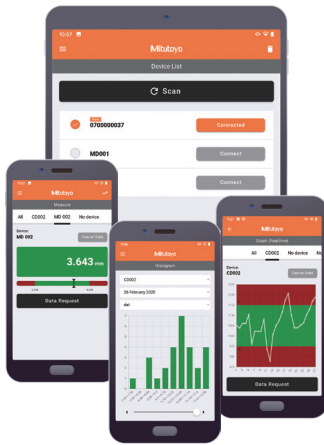

The measurement data is used to make the software in the PC Transferable PC Communication Software U-WAVEPAK-BW.

The Google Play and Google Play logos are trademarks of Google LLC. The Apple and Apple logos are trademarks of Apple Inc.



U-WAVE-TMB



MeasurLink ENABLED
Data Management Software by Mitutoyo

10% OFF

U-WAVE-TCB



U-WAVE-TMB/TCB*

Order No.	Model	Measuring Instrument*	Remarks	List	Promo
264-624-IP-S	U-WAVE-TCB	4", 6", 8", 12" standard caliper	TRANSMITTER AND CONNECTION UNIT	\$285.00	\$256.50
264-624-IP	U-WAVE-TCB	4", 6", 8", 12" IP67 caliper	TRANSMITTER AND CONNECTION UNIT	\$285.00	\$256.50
264-626-IP-M	U-WAVE-TMB	COOLANT-PROOF (IP65) micrometer	TRANSMITTER AND CONNECTION UNIT	\$285.00	\$256.50
02AZF700-TMB	U-WAVE-TMB	0.5" (12.5MM) STROKE for S1 INDICATORS	TRANSMITTER AND CONNECTION UNIT	\$320.00	\$288.00
02AZG011-TMB	U-WAVE-TMB	1" (25.4MM) STROKE OR LARGER for S1 INDICATORS	TRANSMITTER, BRACKET, AND CONNECTION UNIT	\$385.00	\$346.50

* No U-WAVE Receiver required

Prices effective March 15, 2024 through June 28, 2024

U-WAVE Wireless Data Transmitters

The new Mitutoyo U-WAVE Fit wireless data transmitter fits to the back of popular Mitutoyo hand-held measuring instruments. This new design allows for a snug fit behind the display resulting in a more ergonomic feel. U-WAVE Fit is the same technology as the U-WAVE T, just a smaller version.

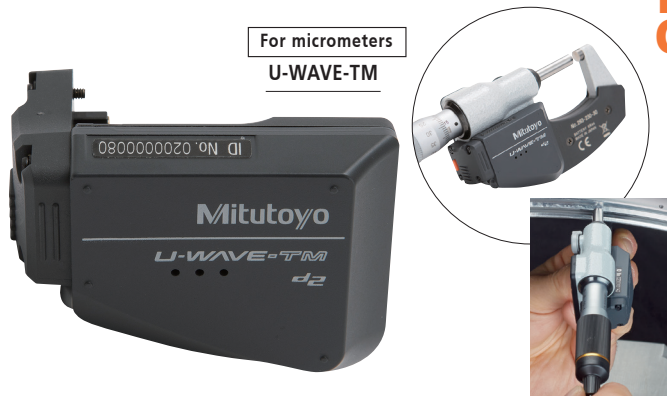

10% OFF



MeasurLink ENABLED
Data Management Software by Mitutoyo

U-WAVE-TM for micrometers and U-WAVE-TC for calipers are available both as, the buzzer and water/dust-proof IP67 types. The buzzer type notifies the normal reception of data by LED and buzzer sound. The water/dust-proof IP67 type is designed for harsh environments and therefore, is only equipped with LED notification of data reception.

U-WAVE-Fit (Transmitter)

Order No.	Model	Measuring Instrument*	Remarks	List	Promo
264-620-IP-S	U-WAVE-TC	4", 6", 8", 12" IP67 standard caliper	TRANSMITTER AND CONNECTION UNIT	\$285.00	\$256.50
264-620-IP	U-WAVE-TC	4", 6", 8", 12" IP67 caliper	TRANSMITTER AND CONNECTION UNIT	\$285.00	\$256.50
264-622-IP-M	U-WAVE-TM	COOLANT-PROOF (IP65) micrometer	TRANSMITTER AND CONNECTION UNIT	\$285.00	\$256.50
02AZF700-TM	U-WAVE-TM	0.5" (12.5MM) STROKE for S1 INDICATORS	TRANSMITTER AND CONNECTION UNIT	\$320.00	\$288.00
02AZG011-TM	U-WAVE-TM	1" (25.4MM) STROKE OR LARGER for S1 INDICATORS	TRANSMITTER, BRACKET, AND CONNECTION UNIT	\$385.00	\$346.50

* Please contact Mitutoyo or distributor for further details

- The transmitter is designed to fit in the space behind the display, and the connecting cable has been replaced by a rigid connector
- Approx. 20 m transmission range (within visible range)
- 2.4GHz wireless system for reliable and secure data transmission
- Easy data export to Microsoft® Excel® or SPC software applications
- Transmitter confirms data transfer by an LED signal and optional buzzer
- An IP67 transmitter is available to ensure a coolant-proof gaging system
- Low power consumption: 400,000 data transmissions with a single battery

U-WAVE-R (Receiver)

Order No.	Remarks	Software	Number of U-WAVE-R units that can be connected to PC	Number of U-WAVE-T units that can be connected	List	Promo
02AZD810D	U-WAVE-R + software	U-WAVE PAK	Up to 15	Up to 100	\$549.00	\$494.10

MeasurLink Quality Data Management Software

Monitor, analyze, collect, calibrate, report and improve.

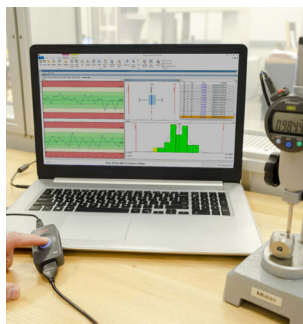

Achieve Total Quality Management with the Total Quality MeasurLink® license. This is a single floating license that can be accessed by anyone and anywhere on the network with every single module. For the engineer(s) who wants total freedom to continuously improve their quality department. No annual fees.

Order No.	Remarks	List	Promo
64AAB855F	MeasurLink V10 Single Floating License	\$3,110.00	\$2,488.00

TQM License Includes:

- > Real-Time SPC
- > Advanced Data Analysis
- > Automated Reporting and Analysis
- > Data Collection Alerts
- > Gage Inventory Management
- > Gage Calibration
- > Gage R&R
- > Automated Ballooning
- > And more!

Solution for Battery Foil Thickness Measurement

The key to success:

High accuracy thickness measurement of battery foil samples

- > The combination of the Litematic and the vacuum plate system provides high accuracy measurement of easily deformed material.
- > Litematics allow measurements at forces as low as 0.01N. The ceramic ball contact included with the Vacuum Packages will increase the force to 0.04N.
- > The vacuum plate absorbs the contact-sensitive specimen, such as a battery film, onto the plate surface for more stable measurement.
- > Mitutoyo America provides vacuum plate packages as well as custom made solutions.
- > Optional set O2AZE375 enables the application of up to 10 intermediate forces.
- > Data export to MeasurLink® and MS Excel.

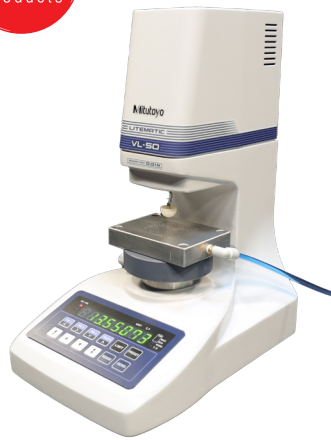
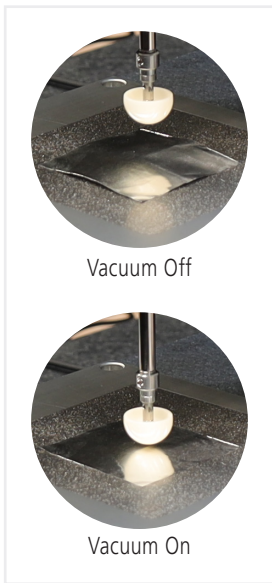
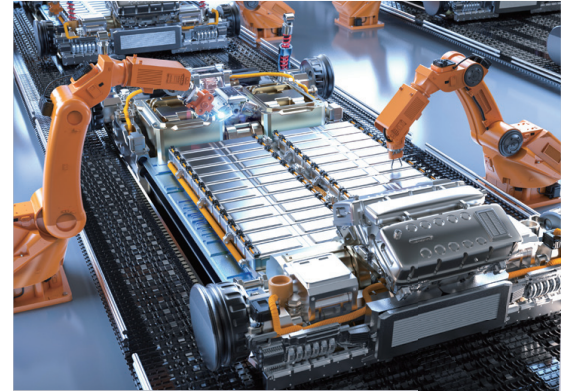

318-221A + 64PKA297



318-221A + K543722



318-226A + 64PKA298 + 957460



Stand-alone Litematic Main Unit

Code	Model	Test Force*	List	Promo
318-221A	VL-50-B	0.01N	\$9,710.00	\$8,739.00

- > Measuring accuracy (20°C) up to $(0.5+L/100)$ μ m L=arbitrary measuring length (mm)
- > Repeatability up to 0.05 μ m
- *The ceramic ball contact included with Vacuum Packages will add 0.03N



Vacuum Package Add-Ons

Code	Model	List	Promo
64PKA297	50x50mm Vacuum Package	\$4,300.00	\$3,870.00
K543722	Laser activated Vacuum Package	\$9,350.00	\$8,415.00



Separate Type Litematic Main Unit

Code	Model	Test Force*	List	Promo
318-226A	VL-50S-B	0.01N	\$9,710.00	\$8,739.00
957460	Granite Stand		\$5,010.00	\$4,509.00

- > Measuring accuracy (20°C) up to $(0.5+L/100)$ μ m L=arbitrary measuring length (mm)
- > Repeatability up to 0.05 μ m
- *The ceramic ball contact included with Vacuum Packages will add 0.03N



Vacuum Package Add-Ons

Code	Model	List	Promo
64PKA298	100x100mm Vacuum Package	\$5,340.00	\$4,806.00

EJ Series Industrial interface-mounted compact counter

Compact size and easy to use

Up to 8 compact counters (EJ counters) can be linked providing the capacity to connect up to 16 gages. On a DIN rail, each unit can be connected directly without using cables, so it takes up minimal space. All linked units and gages can be driven by a single power source.

EtherNet/IP, CC-Link, PROFINET, EtherCAT or USB Connection

Data can be output through an industrial interface by linking a compact counter (EJ counter) with an interface unit. Constant data monitoring and positional management are performed. A USB interface is also provided for easy connection with a computer.

Note: The range of interfaces is set to be expanded in the near future.

Calculation function

Enables sum difference operations between 2 gages connected to the same counter. Functions such as tolerance judgment and peak hold are also included.

Linear Gage LG100 Series

542-190/542-191/542-192
(10 mm stroke)



542-193/542-194/542-195
(25 mm stroke)



542-196/542-197
(50 mm stroke)



Order No	Description	List	Promo
542-190	LG100-110, Range: .4"/10mm, Res: .00005"/1µm	\$630.00	\$598.50
542-193	LG100-125, Range: 1"/25mm, Res: .00005"/1µm	\$803.00	\$762.85
542-196	LG100-150, Range: 2"/50mm, Res: .00005"/1µm	\$973.00	\$924.35
542-191	LG100-0510, Range: .4"/10mm, Res: .00002"/0.5µm	\$687.00	\$652.65
542-194	LG100-0525, Range: 1"/25mm, Res: .00002"/0.5µm	\$860.00	\$817.00
542-197	LG100-0550, Range: 2"/50mm, Res: .00002"/0.5µm	\$1,030.00	\$978.50
542-192	LG100-0110, Range: .4"/10mm, Res: 5µinch/0.1µm	\$745.00	\$707.75
542-195	LG100-0125, Range: 1"/25mm, Res: 5µinch/0.1µm	\$917.00	\$871.15

Linear Gage LG200 Series

542-186/542-187/542-188



Order No	Description	List	Promo
542-188	LG200-0110, Range: 0.4"/10mm, Res: .00005"/0.1µm	\$838.00	\$754.20
542-187	LG200-0510, Range: 0.4"/10mm, Res: .00002"/0.5µm	\$783.00	\$704.70
542-186	LG200-110, Range: 0.4"/10mm, Res: .00005"/1µm	\$727.00	\$654.30



Order No	Description	List	Promo
542-081	Main EJ Module Counter	\$545.00	\$517.75
542-081A	Main EJ Module w/AC Components	\$630.00	\$598.50
21HZA149	USB only interface	\$400.00	\$380.00
21HZA186	CC-Link Module (Mitsubishi), and USB	\$888.00	\$843.60
21HZA187	PROFINET Module	\$888.00	\$843.60
21HZA188	EtherNet/IP Module	\$922.00	\$875.90
21HZA264	EtherCat Module	\$884.00	\$839.80

High accuracy

Precision and accuracy demanded by the automated assembly and inspection markets, are guaranteed. Due to our expertise as a manufacturer of measuring instruments, repeatability in the full measurement range (2σ) and narrow-range precision are also guaranteed.

Environment resistance

Sliding durability of more than 50 million cycles*, with protection level of IP67G. A highly oil-resistant material is used in the rubber cap and cable sheath, so it can be used even in harsh environments.

* 10 mm range models (Actual value from in-house tests)

Reference point detection (LG100 Series)

Reference point signal output functions are featured throughout this series. When incorporating into a device the master setting value is easy to set and is retained after shutdown.

LG QuickSetup Tool

A configuration tool is FREE for use with the EJ counter when connected via the optional USB interface. Multiple settings normally carried out with counter operating keys can now be easily applied from a computer. Live displays allow for easily viewing gage positions or measurements at a glance.

Note: This software can be used free of charge and downloaded from the Mitutoyo website.
<https://www.mitutoyo.co.jp/eng/contact/products/lg/>

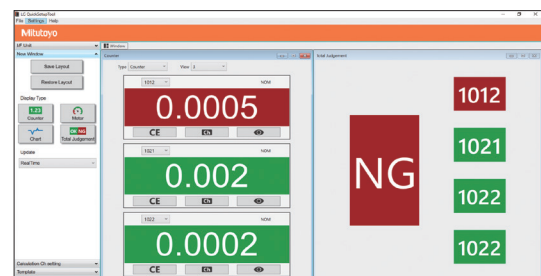

Digimatic Quill Kit

Easy Installation, Fits Most Vertical Knee Mills

- > Easy-to-read LCD with resolution of .0005"/0.01mm. 0-6" travel.
- > Push-button controls for inch/mm, Zero-Set and On/Off.
- > Powered by a single SR-44 Battery which lasts about 1 year with normal use.
- > SPC Output for data transmission to data processors or a remote display.
- > ABS encoder.

MeasurLink ENABLED
Data Management Software by Mitutoyo

SPC **ABSOLUTE**[™]

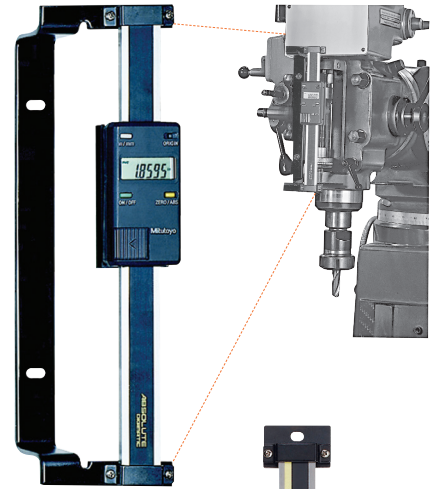

Order No.	Description	List	Promo
053906B	Digimatic Quill Kit complete with brackets & scale for Bridgeport Type machines.	\$356.00	\$338.20

ABSOLUTE Digimatic Scale Units

- > The Origin key allows setting of an absolute zero point to be used as reference in subsequent measurements. Once set, the ABS Digimatic Scale Unit is ready to show its true position whenever turned on, rather than 0.00" as with standard models.
- > The Zero/ABS key allows the display to be zero-set at any slider position along the beam for incremental comparison measurements. This key will also allow return to the absolute coordinate with a display of the true position from the origin point.
- > No rack, no pinion, no glass scale. Digimatic scale unit is safely embedded in the hardened stainless steel blade.
- > Horizontal or vertical face according to the scale mounting direction.
- > Multi-function types with diameter displaying function are also available for lathes. (Contact Mitutoyo.)
- > All units come with two mounting brackets, each located at either end of the scale.
- > With SPC data output.

SPC **ABSOLUTE**[™]



Order No	Model	Range	Accuracy	Resolution	Type	List	Promo
572-210-30	SD-4"DX	0-4" / 0-100mm	.001" / 0.03mm	.0005" / 0.01mm	Horizontal single-function	\$269.00	\$255.55
572-211-30	SD-6"DX	0-6" / 0-150mm	.001" / 0.03mm	.0005" / 0.01mm	Horizontal single-function	\$285.00	\$270.75
572-212-30	SD-8"DX	0-8" / 0-200mm	.001" / 0.03mm	.0005" / 0.01mm	Horizontal single-function	\$332.00	\$315.40
572-213-10	SD-12"D	0-12" / 0-300mm	.002" / 0.04mm	.0005" / 0.01mm	Horizontal single-function	\$641.00	\$608.95
572-310-10	SDV-6"D	0-4" / 0-100mm	.001" / 0.03mm	.0005" / 0.01mm	Vertical single function	\$298.00	\$283.10
572-311-10	SDV-6"D	0-6" / 0-150mm	.001" / 0.03mm	.0005" / 0.01mm	Vertical single-function	\$316.00	\$300.20
572-312-10	SDV-8"D	0-8" / 0-200mm	.001" / 0.03mm	.0005" / 0.01mm	Vertical single function	\$367.00	\$348.65
572-313-10	SDV-12"D	0-12" / 0-300mm	.002" / 0.04mm	.0005" / 0.01mm	Vertical single function	\$705.00	\$669.75

MeasurLink ENABLED
Data Management Software by Mitutoyo

Applications

Machine table position

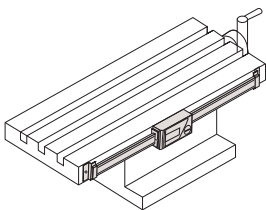

Drilling machine stroke position

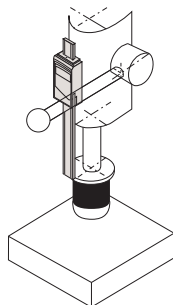

Focus setting on optical instruments

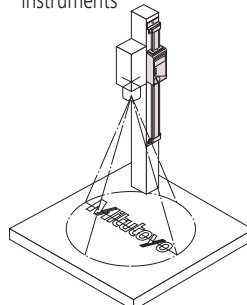

Special Applications

As a measurement jig for outdoor use (SD-G)

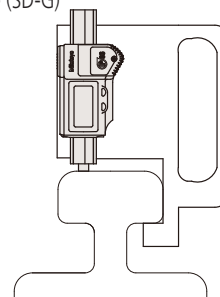

Detector head mechanism

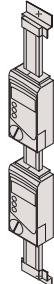

Linear Encoders for Lathes, Grinders, and Mills

Mitutoyo Digital Readout Packages

Mounting Hardware Included on all machine retrofit packages

SAVE
\$200
PER PACKAGE



All DRO Packages Include:

- > KA-200 Counter
- > KA-200 Counter tray/arm kit
- > High Resolution Linear Scales (down to .0001" or better!)
- > Bracket Kit(s)

MeasurLink ENABLED
Data Management Software by Mitutoyo

Package Part No.	Description	X Travel	Y Travel	Z Travel	X Axis Type	Y Axis Type	Z Axis Type	List	Promo
64PKA058B	12" X 30" DRO Mill Package	30"	12"		AT715	AT715		\$1,640.00	\$1,440.00
64PKA059B	12" X 36" DRO Mill Package	36"	12"		AT715	AT715		\$1,710.00	\$1,510.00
64PKA060A	14" X 30" DRO Mill Package	30"	14"		AT715	AT715		\$1,710.00	\$1,510.00
64PKA062B	16" X 36" DRO Mill Package	36"	16"		AT715	AT715		\$1,710.00	\$1,510.00
64PKA063A	16" X 40" DRO Mill Package	40"	16"		AT715	AT715		\$1,710.00	\$1,510.00
64PKA035A	6" X 28" Lathe Package	6"		28"	AT116		AT715	\$1,660.00	\$1,460.00
64PKA039A	8" X 40" Lathe Package	8"		40"	AT116		AT715	\$1,660.00	\$1,460.00
64PKA042A	10" X 40" Lathe Package	10"		40"	AT116		AT715	\$1,660.00	\$1,460.00
64PKA046A	12" X 40" Lathe Package	12"		40"	AT116		AT715	\$1,660.00	\$1,460.00
64PKA050A	12" X 60" Lathe Package	12"		60"	AT116		AT715	\$1,890.00	\$1,690.00
64PKA052A	14" X 40" Lathe Package	14"		40"	AT116		AT715	\$1,660.00	\$1,460.00
64PKA057A	16" X 60" Lathe Package	16"		60"	AT116		AT715	\$1,890.00	\$1,690.00
64PKA026A	6" X 12" Grinder Package	6"		12"	AT116		AT116	\$1,850.00	\$1,650.00
64PKA028A	8" X 12" Grinder Package	8"		12"	AT116		AT116	\$1,850.00	\$1,650.00
64PKA029A	8" X 14" Grinder Package	8"		14"	AT116		AT116	\$1,850.00	\$1,650.00

Other packages and kits are available for mills, lathes, grinders and custom machines and applications. Contact your local distributor for details.

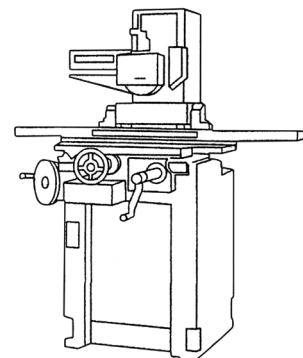
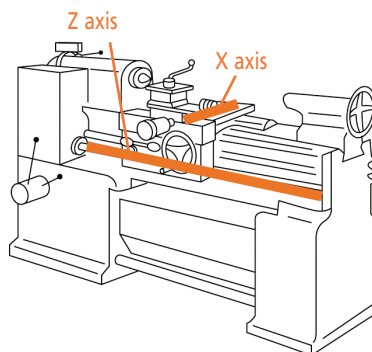
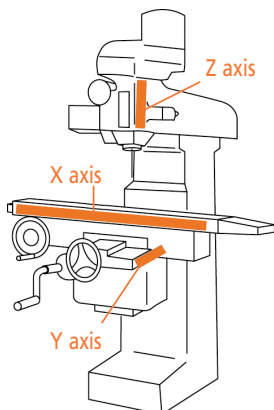



Rockwell and Rockwell Superficial Hardness Tester

With Real-Time Electronic Test Force Control

- > Closed-loop control of testing forces.
- > Initial and Total test forces (loads) are applied with unparalleled accuracy and repeatability.
- > Extended indenter arm reaches inside diameters and hard-to-reach surfaces at eye level, allowing the operator to easily see where the indenter accesses small or hard-to-reach parts.
- > Automatic cycle start after initial set point is reached.
- > Continuous test mode for automatic testing of all like sized parts.
- > All hardness parameters set automatically via the touch screen.
- > Cylindrical and spherical surface corrections.
- > Auto conversion to most common hardness scales or tensile strength.



Model No.	810-233-33A		810-333-33A	
Order No.	HR-530		HR-530L	
Hardness testing methods	Rockwell / Rockwell Superficial / Brinell / Plastics Hardness			
Initial Test Force	29.42 N (3kgf), 98.07 N (10kgf)			
Test Force (N)	Superficial	147.1 N (15kgf), 294.2 N (30kgf), 441.3 N (45kgf)		
	Rockwell	588.4 N (60kgf), 980.7 N (100kgf), 1471 N (150kgf)		
	Light Force Brinell	61.29 N (6.25kgf), 98.07 N (10kgf), 153.2 N (15.625kgf), 245.2 N (25kgf), 294.2 N (30kgf), 306.5 N (31.25kgf), 612.9 N (62.5kgf), 980.7 N (100kgf), 1226 N (125kgf), 1839 N (187.5kgf)		
Test Force Control	Automatic (load / hold / unload)			
Maximum Specimen Size	Height: 9.8" (250mm) Depth: 5.9" (150mm)		Height: 15.5" (395mm) Depth: 5.9" (150mm)	
External Data Output	RS-232C, digimatic, USB2.0			
External Dimensions	Main Unit	9.84" x 26.38" x 23.82" (250 w x 667 d x 621 h mm)		11.6" x 26.2" x 30.1" (300 w x 667 d x 766 h mm)
	Touch-Panel Display	191 w x 147 d x 71 h mm (Color)		
Mass	Approx. 60 kg		Approx. 69 kg	
	List	\$16,600.00		\$20,000.00
Promo	\$14,940.00		\$18,000.00	

10% OFF 10% off all Packages

FREE SHIPPING Free Shipping

Installation & Calibration Included

HR-530
810-233-33A

10% OFF 10% off all Packages

FREE SHIPPING Free Shipping

Installation & Calibration Included

HR-530L
810-333-33A



For more information regarding compatible accessories such as fixtures, indenters, and calibration blocks use the QR Code!



ASTM Compliant HR Series Rockwell and Superficial Hardness Tester Packages Include:

- > Certified Blocks and Indenters
- > C and N Scale Indenter
- > 1/16" Carbide Ball Indenter
- > HRC30 Rockwell Test Block
- > HRC63 Rockwell Test Block
- > HRBW95 Rockwell Test Block
- > HR30N60 Rockwell Test Block
- > HR30TW70 Rockwell Test Block

Calibration Set

Order No.	Order No.	Order No.	Order No.
64HAA462	64HAA463	64HAA464	64HAA465
HRC Scale	HRBW Scale	HR30N Scale	HR30TW Scale
Test Blocks	Test Blocks	Test Blocks	Test Blocks
64HAA181	64HAA172	64HAA270	64HAA303
64HAA177	64HAA170	64HAA266	64HAA301
64HAA173	64HAA168	64HAA262	64HAA299
Universal Style Indenter with Flat			
64HAA100	64HAA119	64HAA101	64HAA119

- > Certificate stating conformance to ASTM E 18
- > Mitutoyo Installation and A2LA Calibration

HR-430MR includes only diamond indenter, C scale indenter, HRC and HRBW blocks listed above



SCAN ME

A Complete Line of ASTM Compliant Rockwell Hardness Testing Machines

10% OFF 10% off all Packages

FREE SHIPPING Free Shipping

Installation & Calibration Included



	HR-320MS	HR-430MR	HR-430MS	HR-530/HR-530L	HR-610A/HR-620A	HR-620B
Rockwell Scales		X				
Rockell and Superficial	X		X	X	X	X
Dead Weight	X	X	X			
Individual Hanging Weights	X					
Dial Weight		X	X			
Automatic break		X	X			
Closed Loop				X	X	X
Digital Display	X	X	X	X	X	X
7.1" Max Sample Height	X	X	X			
9.8" Max Sample Height				HR-530	X	X
15.5" Max Sample Height				HR-530L		
6.5" Max Depth	X	X	X			
5.9" Max Depth						
8.6" Max Depth				X	X	X
CNC						X
Motorized X Stage (Optional)					X	X
Motorized Y Stage						X
Software Control and Analysis						X
ASTM Compliant HR Series Rockwell & Rockwell Superficial Packages - All 10% Off	810-192-31A	810-193-21A	810-194-21A	810-233-33A (HR530) or 810-333-33A (HR530L)	810-512-23A (HR610A) or 810-522-23A (HR620A)	810-527-21A
List	\$10,900.00	\$11,100.00	\$11,600.00	\$16,600.00 / \$20,000.00	\$28,100.00 / \$30,400.00	\$48,800.00
Promo	\$9,810.00	\$9,990.00	\$10,440.00	\$14,940.00 / \$18,000.00	\$25,290.00 / \$27,360.00	\$43,920.00

Hand Tool Hardness Durometers (Digital and Analog)

For Rubber and Plastic Hardness Testing

10% OFF

Compact Dial 811-335-10



Compact Digital 811-336-10



MeasurLink ENABLED
Data Management Software by Mitutoyo

Order No	Model	Scale	Display	Graduation	Range	Indenter	List	Promo
811-335-10	HH-335	Shore A	Analog	1.0	10~90	Blunt Taper	\$686.00	\$617.40
811-336-10	HH-336	Shore A	Digital	0.5	10~90	Blunt Taper	\$1,470.00	\$1,323.00
811-337-10	HH-337	Shore D	Analog	1.0	20~90	Sharp Point	\$686.00	\$617.40
811-338-10	HH-338	Shore D	Digital	0.5	20~90	Sharp Point	\$1,470.00	\$1,323.00

HH-411 Hardmatic

Rebound Leeb portable hardness tester featuring reproducibility and ease of operation on large parts. It is lightweight and can be carried into the shop or out in the field.

MeasurLink ENABLED
Data Management Software by Mitutoyo



Order No.	Type	List	Promo
810-298-10	HH-411 Hardmatic	\$4,580.00	\$4,122.00

Micro Vickers Hardness Testers - HM Series

- > HM Type A systems include a built-in measuring eyepieces for indentation analysis and accurate workpiece positioning
- > Automatic Turret (Touch-screen controlled in Type A systems and software controlled via AVPAK in Type B and D systems)
- > Test force range 10g-1000g (HM-210) and .05-2000g (HM-220)
- > LED illumination
- > Type B and D systems include a camera for software analysis (Type A systems can use optional camera for digital imagery)
- > Type A and B systems use micrometer controlled adjustable stages and Type D systems utilize a motorized XY Stage

10% OFF 10% off all Packages



FREE SHIPPING Free Shipping



Installation & Calibration Included



MeasurLink ENABLED
Data Management Software by Mitutoyo

Seamless assistance is a scan away - Connect with your local representative by making an inquiry today!



SCAN ME

10% OFF ALL HARDNESS TESTERS!

Functions	System A	System B	System D
Focusing	Manual	Manual	Automatic
Testing Action	Single Point	Single Point	Pattern Specific
Test-point Positioning	Manual X-Y Stage	Manual X-Y Stage	Automatic X-Y Stage
Measuring Indentations	Manual Monoscope	Automatic by AVPAK	Automatic by AVPAK
Camera (for observing and measuring indentations)	600,000 pixels B&W*	Color, 3 million pixels	Color, 3 million pixels
Operating the main unit	Touchel Panel	PC**	PC**
Order No	64AAB305PA	64AAB323PA	64AAB380PA
Main Unit	HM-210A	HM-210B	HM210D
List	\$24,000.00	\$41,200.00	\$71,100.00
Promo	\$21,000.00	\$37,080.00	\$63,990.00

** PC sold separately

Heavy Load Hardness Testers - HV Series

Highly Versatile Basic Model

HV-110/120 System A

- > Equipped with a high performance motorized test force selection function and motorized turret mounts.
- > Operates as smoothly as electric models but with the certainty of traditional test forces.
- > A List function make it easy to perform multi-point and average hardness evaluations, which required extra effort or external data processors with conventional manual models. This convenient screen enables consistency of test results.
- > Motorized test force selection and motorized turret positions can be easily controlled via a touch screen control panel. Adjustable X-Y stage with built-in digital micrometers for detailed measurement analysis



Advanced models promise additional productivity improvements

HV-110/120 System B,C,D

- > B,C and D series testers feature AVPAK dedicated image software enabling automatic indentation reading with excellent automatic edge detection capability, reducing reading variation and visual error.
- > C and D series testers add powered X-Y stages which enable automatic continuous testing. This allows extended multi-point testing, complex pattern creation and multiple work piece analysis now carried out automatically.
- > D series testers add Auto Focus and create a fully automatic system that dramatically shortens the cycle time of your test and indentation analysis!

To set up a demonstration or get more information please use the QR code.



SCAN ME

Prices effective March 15, 2024 through June 28, 2024

Ultra-High Accuracy

Laser Scan Micrometer LSM-6902H



- > Improved narrow range Repeatability of 0.03 μ m / 1.2 μ in
- > The best repeatability available in the 25mm/1" class.
- > The ultra-precise scanning motor enables the highest measurement accuracy.
- > Thanks to excellent linearity, an accuracy of $\pm 0.5\mu$ m over the entire measuring range and a higher accuracy of $\pm(0.3+0.1\Delta D)\mu$ m over a narrow range are guaranteed.
- > An excellent option for measuring pin gages or plug gages.



544-499A

Order No	Range	Resolution	List	Promo
544-499-1A	.004" - 1.0"/0.1mm - 25mm	.000001" - .0005"/0.00001 - 0.01mm	\$13,900.00	\$12,510.00
544-116-1A	.020" - 2.36"/0.5mm - 60mm	.000002" - .005"/0.00005 - 0.1mm	\$10,200.00	\$9,180.00

QUICKTOOL* is free downloadable software that makes programming the LSM-6200 quick and easy.
*For use with customer-supplied PC and optional RS-232C cable.

High-Accuracy Non-Contact Measuring Systems

- > Excellent linearity: down to +/- 0.3 micron.
- > High-speed scanning capable: 3,200 scans per second.
- > Various ranges available for selecting the best laser for your application.
- > Statistical calculation mode.
- > Memory function has been increased to allow storage of up to 100 programs.

QUICKTOOL* is free downloadable software that makes programming the LSM-6200 quick and easy.
*For use with customer-supplied PC and optional RS-232C cable.

LSM-6200 Display Unit Included



Order No	Model	Range Inch	Range mm	Repeatability	Linearity	Scanning Rate	List	Promo
64PKA117	LSM-500S	.0002" - .08"	0.005~2mm	$\pm 0.03\mu$ m	$\pm 0.3\mu$ m	3,200 scans/sec	\$11,900.00	\$8,092.00
64PKA118	LSM-501S	.002" - .4"	0.05~10mm	$\pm 0.04\mu$ m	$\pm 0.5\mu$ m [†]	3,200 scans/sec	\$10,700.00	\$6,955.00
64PKA119	LSM-503S	.012" - 1.18"	0.3~30mm	$\pm 0.11\mu$ m	$\pm 1.0\mu$ m [†]	3,200 scans/sec	\$11,600.00	\$7,888.00
64PKA120	LSM-506S	.04" - 2.36"	1~60mm	$\pm 0.36\mu$ m	$\pm 3\mu$ m [†]	3,200 scans/sec	\$13,200.00	\$9,372.00
64PKA121	LSM-512S	.04" - 4.72"	1~120mm	$\pm 0.85\mu$ m	$\pm 6\mu$ m [†]	3,200 scans/sec	\$20,300.00	\$16,443.00
64PKA122	LSM-516S	.04" - 6.30"	1~160mm	$\pm 1.4\mu$ m	$\pm 7\mu$ m [†]	3,200 scans/sec	\$32,600.00	\$28,688.00

[†] Linearity over entire range. Higher accuracies are possible over smaller ranges.

Bench Top

Laser Scan Micrometer LSM-9506

- > Integrated display and measuring unit in one unit.
- > Statistical calculation mode.
- > RS-232C output, I/O interface, and SPC output interface are standard.



544-116-1A



Package

FREE
LSM 6200
DISPLAY!

UP TO 35% OFF!



On-line measurement of glass fiber or fine wire diameter

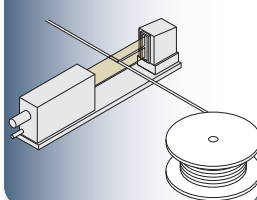

Measurement of outer diameter of cylinder

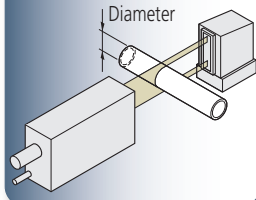

Measurement of outer diameter and roundness of cylinder

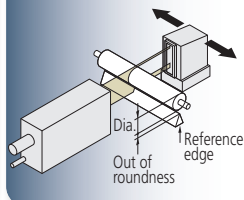

X- and Y-axis measurement of electric cables and fibers

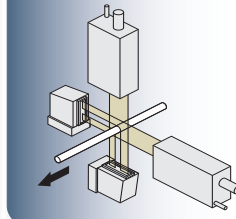

Measurement of thickness of film and sheet

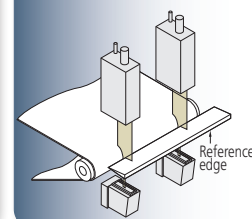

MF Measuring Microscopes with Metlogix M2 Software and Touch-Screen Tablet

Featuring M2 geometric measuring display

- > Highest measuring accuracy in its class
- > Stage travel range up to 400mm x 200mm / 16in x 8in
- > Quick release mechanism and zero-set buttons on stage controls increase operability when working larger workpieces
- > Easy to use all-in-one PC Touch Screen Display
- > M2 Geometric 2D Measurement Software
- > Camera port is standard on all models
- > Wide range of objectives available from 1x to 100x
- > M2 Retrofit package available for D generation MF and MF-U microscopes
- > Microscope packages with M2 software and tablet are listed below

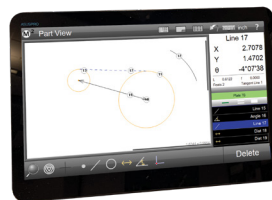

176-863-10PK1 - MF-A2017, LED, MONOCULAR TUBE, w/ M2 SYSTEM

Sample Packages

Order No	Description	List	Promo
176-861-10PK1	MF-A1010, LED, MONOCULAR TUBE, WITH M2 SYSTEM	\$22,400.00	\$20,160.00
176-861-10PK2	MF-A1010, LED, BINOCULAR TUBE, WITH M2 SYSTEM	\$23,500.00	\$21,150.00
176-863-10PK1	MF-A2017, LED, MONOCULAR TUBE, WITH M2 SYSTEM	\$29,200.00	\$26,280.00
176-863-10PK2	MF-A2017, LED, BINOCULAR TUBE, WITH M2 SYSTEM	\$30,400.00	\$27,360.00
64PKA234	M2 Retrofit Kit for MF / MF-U Microscopes M2 2D Data Processing Unit with software and hardware, including a tablet PC. This package includes on-site installation and calibration for customers with existing MF of MF-U Microscopes	\$4,300.00	\$3,870.00

MeasurLink[®] ENABLED
Data Management Software by Mitutoyo

Want to take a closer look?
Scan the QR code to make your product inquiry today!



SCAN ME

MF-U Measuring Microscopes

- > Measuring accuracy that is highest in its class (and conforms to JIS B 7153)
- > Compatible with both brightfield and darkfield objective lenses
- > Manual or motorized turrets available dependent on model
- > Compatible with M2 retrofit Kit

Model No. (XY stage size)	MF-UA2010D
XY stage travel range	8 x 4" / 200 x 100mm
Z-axis travel range	6" / 150mm
Focusing method	Manual focusing (Coarse focusing: 30mm/rev., Fine focusing: 0.2mm/rev.)
Measurement method	Linear encoder (2-axis model: X / Y-axis)
Resolution (switchable)	.0001" / .00005" / .00001" (0.001mm / 0.0005mm / 0.0001mm)
Measuring accuracy (at 20°C)	XY-axis: (2.2+0.02L)µm, L = Measuring length (mm) when not loaded, JIS B 7153
Floating function	X and Y axes with Quick-release mechanism
XY stage top size	13.78 x 11.02" / 350 x 280 mm
Effective glass size	9.84 x 5.09" / 250 x 150 mm
Max. stage loading	22lbs / 10kg
Max. workpiece height	6" / 150mm

MeasurLink[®] ENABLED
Data Management Software by Mitutoyo



176-872-10 MF-UA2010 - M2 Software/Hardware

To learn more about our MF and MF-U Microscopes please visit our webpage.



SCAN ME

TM Toolmakers' Microscopes

- › Adjustable illumination intensity.
- › Angle measurement is performed easily by turning the angle scale disc to align the cross-hair reticle with the workpiece image.
- › Includes standard accessories create an overall magnification of 30X. Magnifications can be changed from 20 - 200X by using optional objectives and/or eyepieces.
- › .000050" Resolution Digimatic micrometer heads included.

10% OFF

MeasurLink[™] ENABLED
Data Management Software by Mitutoyo

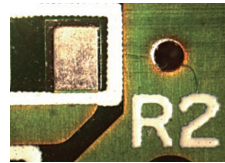

Newly designed LED illumination



TM-A505B
176-820A

Model No.	TM-A505B		TM-A1005B	
Order No.	176-820A		176-821A	
Eyeiece	Standard accessory: 15X (field number: 13), Options: 10X, 20X			
Objective lens	Standard accessory: 2X, Options: 5X, 10X			
Microscope head	Maximum height of workpiece	4.53" / 115mm	4.21" / 107mm	
Illumination unit	Transmitted illumination	Stepless brightness adjustment, White LED light source, with green filter		
	Surface illumination	Oblique single-source type, Stepless brightness adjustment, White LED light source		
Cross-travel stage	Measuring range	2" x 2" / 50x50mm	4" x 2" / 100x50mm (An optional 2"/50mm gage block is required to cover full range. A CERA block is recommended.)	
	Usable area of the stage glass	3.8" x 3.8" / 96x96mm	6" x 3.8" / 154x96mm	
	Maximum stage glass loading	11 lbs. / 5kg		
Linear measurement method	Micrometer heads included			
List	\$6,410.00		\$8,350.00	
	Promo \$5,769.00		\$7,515.00	

Modular MOTICAM accessory for seamless image documentation



Order No.	Description
64PMI247	MOTICAM S1, 1.2 MEGAPIXEL-1/3" CMOS, USB
64PMI249	MOTICAM S3, 3.0 MEGAPIXEL-1/2" CMOS, USB
64PMI248	MOTICAM S6, 6.0 MEGAPIXEL-1/1.8" CMOS, USB
64PMI252	MOTI-CAM 4000, 8 MEGAPIXEL, 1/1.8" CMOS, USB/HDMI
63AAA060	.37x C-Mount Eyetube Adapter

Trinocular Stereo Microscope MSM-414TL

- › Continuous 1X - 4X magnification.
- › Image always in focus throughout zoom range.
- › Crisp, erect images with high resolution and excellent stereoscopic effect.
- › Stereo-tube can be rotated a full 360° for viewing at any angle.
- › Bilateral zoom control knob adds convenience and increases operator efficiency.
- › Diopter adjustment for both eyepieces.

Model	MSM-414TL
Order No.	377-974A
Optical tube	Trinocular
Total magnification	10X - 40X
Eyepiece	10X (377-016)
Objective	1X - 4X
Working distance	80mm
Field of view	20mm - 5mm
Dimensions	H=13.2" x W=6.7" x D=9.3"
Mass	13.2 lbs (6kg)

Order No.	Description	List	Promo
Stereo Microscope Unit			
377-974A	MSM-414TL Stereo Microscope	\$1,580.00	\$1,422.00
Observational Camera Accessories			
377-481	C-mount Video Adapter for MSM-414TL	\$59.35	
64PMI252	MOTI-CAM 4000, 8 MEGAPIXEL, 1/1.8" CMOS, USB/HDMI	\$1,650.00	

377-481 and 64PMI252 purchased separately*



Camera with software for digital viewing



Set your sights on advanced vision systems

The Quick Scope series of digital microscopes offer high accuracy, high magnification manual 3D optical measurements.

Quick Scope Digital Microscope Features:

- > Optimized for Efficiency: High-speed, high-accuracy optical auto-focus for 3D measurements, ensuring rapid and precise results
- > Versatile Illumination: Surface, contour, and ring light options cater to a variety of measurement needs
- > Compact and User-Friendly: Reduced footprint with a quick release system for easy stage movement
- > Advanced Technology: 7X optical zoom captures measurement targets clearly, with high-intensity LED lighting to highlight intricate edges
- > Automatic Edge Detection: Increase speed and accuracy with software edge detection
- > Automatic Focus: Measure in full 3D with motorized Z axis focus
- > Automatic Light: Run programs without the need for operators to adjust the light settings
- > Automatic Part Detection: Place parts without fixturing using pattern recognition
- > Model with 16" Table: Measure parts up to 16" in length

- Factory Installation
- A2LA Accredited Calibration
- Training Included



QS-L2010Z/AFC
359-713-10

MeasurLink ENABLED
Data Management Software by Mitutoyo

Packages

Model	Stage Size	Package No.
QS-L2010Z/AFC	8" x 4" x 6"	359-713-10PK
QS-L3017Z/AFC	12" x 6.7" x 6"	359-714-10PK
QS-L4020Z/AFC	16" x 8" x 6"	359-715-10PK



Traceability to National Standards



The Quick Image series of digital profile projectors offer high accuracy, high speed 2D optical measurements.

Quick Image Digital Profile Projector Features:

- > Precision at Its Best: Highest level of measuring accuracy within its class, ensuring consistent and reliable results
- > Adaptable Optics: Double-telecentric optics eliminate human error, providing a wide field of view and long focal depth
- > Simplified Operations: One-click tool for multiple measurements and high pixel count color CMOS camera for clarity
- > Robust Construction: Designed to handle workpieces up to 16" in size with a maximum load capacity of 44 lbs and vertical stroke of 4"
- > Safety First: Ultra-long working distance of 3.5" ensures safe focusing, even with stepped workpieces
- > Automatic Edge Detection: Increase speed and accuracy with software edge detection
- > Automatic Light: Run programs without the need for operators to adjust the light settings
- > Automatic Part Detection: Place parts without fixturing using pattern recognition
- > Model with 16" Table: Measure parts up to 16" in length



Stitching the Entire View of a Large Workpiece Improves Ease of Operation and Measurement Efficiency

Stitching Function

- > A newly developed correction algorithm stitches multiple images together (multiple image-to-image coupling) while maintaining high-accuracy measurements. After a stitching operation, measurement is easily processed without the need to move the stage.

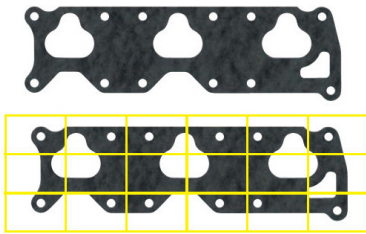

Multiple view-field stitching image

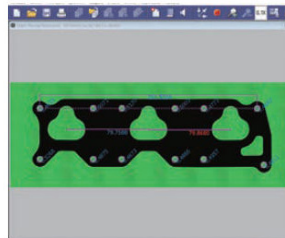

Full (single image) multiple field of view measurement processing and programming

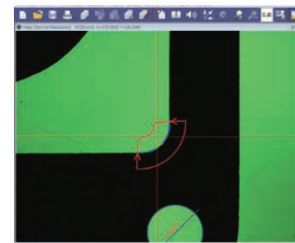

High-accuracy measurement of a small feature is achieved by the image zoom function

		Manual Stage Model					Motorized Stage Models			
		Model No.	QI-A1010D	QI-A2010D	QI-A2017D	QI-A3017D	QI-A4020D	QI-C2010D	QI-C2017D	QI-C3017D
Mag.	0.2x	Order No.	361-850A	361-851A	361-852A	361-853A	361-854A	361-860-11	361-861-11	361-862-11
		Package No.	361-850APK	361-851APK	361-852APK	361-853APK	361-854APK	361-860-11PK	361-861-11PK	361-862-11PK
	0.5x	Model No.	QI-B1010D	QI-B2010D	QI-B2017D	QI-B3017D	QI-B4020D			
		Order No.	361-855A	361-856A	361-857A	361-858A	361-859A			
Measuring Range (X x Y)			3.94" x 3.94" 100 x 100mm	7.87" x 3.94" 200 x 100mm	7.87" x 6.69" 200 x 170mm	11.8" x 6.69" 300 x 170mm	15.7" x 7.87" 400 x 200mm	7.87" x 3.94" 200 x 100mm	7.87" x 3.94" 200 x 170mm	11.8" x 6.69" 300 x 170mm
Travel Range (Z axis)		3.94" (100mm)								
Measurement accuracy (E1xy)		±(3.5+0.02L) μm L: arbitrary measuring length (mm)								

ALWAYS THERE. ALWAYS READY.

YOUR DEDICATED SUCCESS TEAM

Our commitment to you extends far beyond the sale. Our new Customer Success team is a testament to our dedication to providing the industry's best products and services.

The very best products are nothing without reliability and support. Our Customer Success team is always there, ready to help by understanding your unique needs and challenges. They are your single point of contact for anything you may need over the lifetime of your product. They are your liaison, leveraging Mitutoyo's vast expertise to provide comprehensive solutions tailored for your business.

No matter what your need may be, you can always pick up the phone and connect directly with your dedicated customer success. With Mitutoyo, it's not just about the industry's best products, it's about a promise of continued partnership, unparalleled support, and a shared journey towards excellence.



Nationwide Support Infrastructure of Mitutoyo America

Headquarters: Aurora, Illinois

Metrology Services Center (ISO/IEC 17025 Accredited):

Aurora Illinois, City of Industry California, West Chester Ohio

Services:

Aurora Illinois: Calibration, Repair, Field Service, Contract Inspection

City of Industry: Calibration, Repair

West Chester Ohio: Calibration, Contract Inspection, Part

Programming

M³ Solution Centers (Showrooms): Locations (8 in total):

Illinois, Washington, Texas, Ohio, Michigan, California, North Carolina, Massachusetts.

Note: At the M³ Solution Center, customers can not only view our products but also utilize the space to address their measurement challenges through demonstrations of our latest measuring instruments and technologies.

Total Number of Employees: Approximately 400

Mitutoyo products are sold through authorized distributors which can be found at my.mitutoyo.com/General/FindDistributor

My.Mitutoyo.com

Search for products, request a product quote, take online metrology courses, and much more.

Note: All information regarding our products, and in particular the illustrations, drawings, dimensional and performance data contained in this printed matter as well as other technical data are to be regarded as approximate average values. We therefore reserve the right to make changes to the corresponding designs. The stated standards, similar technical regulations, descriptions and illustrations of the products were valid at the time of printing. In addition, the latest applicable version of our General Trading Conditions will apply. Only quotations submitted by ourselves may be regarded as definitive. Specifications are subject to change without notice. We reserve the right to change specifications and prices without notice. Not valid with any other offer or promotion, previous purchases. Please refer to terms and conditions for additional information. Domestic U.S. orders only.

Mitutoyo products are subject to US Export Administration Regulations (EAR). Re-export or relocation of our products may require prior approval by an appropriate governing authority.

Trademarks and Registrations

Designations used by companies to distinguish their products are often claimed as trademarks. In all instances where Mitutoyo America Corporation is aware of a claim, the product names appear in initial capital or all capital letters. The appropriate companies should be contacted for more complete trademark and registration information.

Mitutoyo

Mitutoyo America Corporation

965 Corporate Boulevard

Aurora, Illinois 60502

1-888-648-8869

75M 0324 • Printed in USA • March 2024